

fuma // OUTDOOR – TERRACE/BALCONY PEDESTAL BEARING

Self-levelling

FST 70-Modules are used with self-levelling system in tile applications to create raised floors. Allow auto slope correction on surfaces maximum up to 5% gradient.

// PRODUCT FEATURES

Raw Material	Polypropylene
Installation height	min. 42 mm – max. 120 mm
Maximum extension	2 - 3 pieces Extensions allow for flexible bridging of greater installation heights. When using more than 2 - 3 extensions and an installation height exceeding 30 cm, ensure that a pedestal support is placed every 40 cm to maintain stability. Additionally, a central pedestal support should be positioned under each slab for added support.
Base Diameter	187 mm
Base Wall Thickness	3 mm
Head Diameter	126 mm
Laying Surface of the Base	302 cm²
Tab Thickness	3 mm (removable)
Tab Height	10 mm
Slope Correction	5%
Environmental Impact Assessment	Eco - Friendly
Application Areas	Can be used for all indoor and outdoor areas. Also, on levelled surfaces, epoxy or membrane insulated in areas.
Application	Using any of fixing material is not necessary. Optionally, the modules can be fixed to the application surface using adhesive or screw.



// TECHNICAL DRAWING

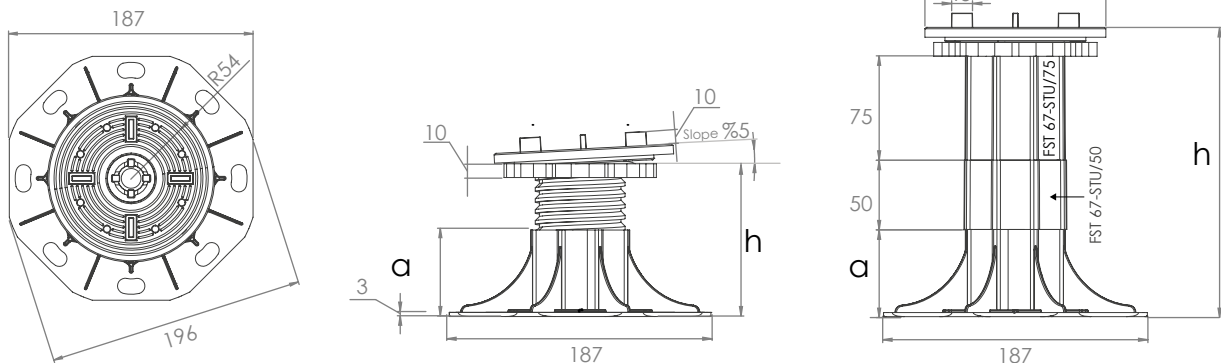

// DIMENSION & WEIGHT

Model	FST 70-01/30-S	FST 70-02/40-S	FST 70-03/55-S	FST 70-04/75-S	Height examples					
a	18 mm	27 mm	40 mm	62 mm	FST 70-03/55-S	FST 70-04/75-S	FST 70-04/75-S	FST 70-04/75-S	FST 70-04/75-S	FST 70-04/75-S
h (min. - max)	42-48 mm	48-60 mm	60-85 mm	83-120 mm	112-140 mm	136-165 mm	157-194 mm	185-215 mm	210-235 mm	230-260 mm
Extension	-	-	-	-	FST 67-STU/50	FST 67-STU/50	FST 67-STU/75	FST 67-STU/50	FST 67-STU/50 FST 67-STU/75	FST 67-STU/75
Weight	0,309 kg	0,330 kg	0,358 kg	0,389 kg	-	-	-	-	-	-
Comp.										

To increase the height kindly use the additional available extension FST 67-STU/50 and / or FST 67-STU/75.

// RAW MATERIAL INFORMATION

Carrier	Polypropylene
Product Code	240 KTPH
Product Colour	Black
Filler	Calcium Carbonate (CaCO ₃)

// NOTES ON INSTALLATION

- For tile sizes of 60 x 60 cm and above, we recommend placing an additional pedestal bearing at the center of each tile.
- For tile sizes of 80 x 80 cm and above, a central pedestal bearing is mandatory.

// PRESSURE RESISTANCE

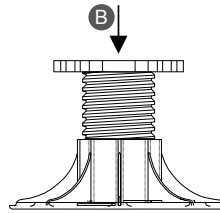
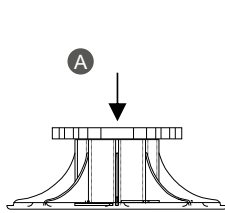

Pressure measuring point

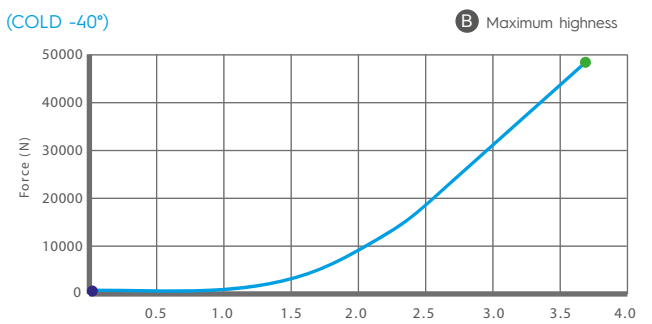
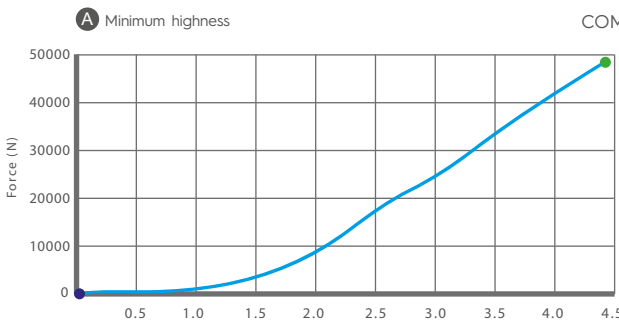
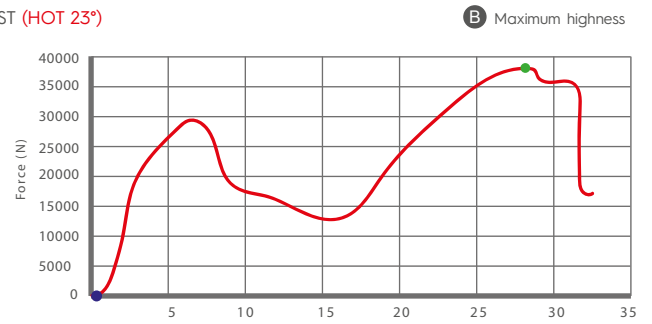
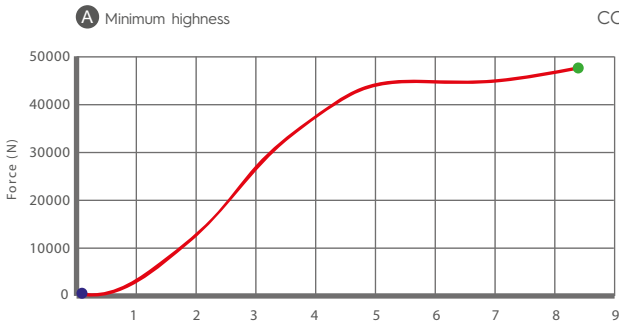

// PACKAGING INFORMATION

Product Code	FST 70-01/30-S	FST 70-02/40-S	FST 70-03/55-S	FST 70-04/75-S	FST 67-STU/50	FST 67-STU/75
Pcs per box	70*	60*	45*	35*	60**	40**
Gross weight per box	22,860 kg	21,030 kg	17,340 kg	14,845 kg	6,920 kg	5,520 kg
Boxes per pallet	12	12	12	12	48	48
Box dimensions	*cm 60 x 40 x h40			**cm 40 x 30 x h20		
Gross weight per pallet	285,490 kg	263,530 kg	219,250 kg	189,310 kg	343,330 kg	276,130 kg
Pallet dimensions	cm 80 x 120 x h140					

* Products are packed in cardboard boxes. Shrink-wrapped euro-pallets are used for final packaging. In spite of being shrink-wrapped and rain proof packagings, recommended to keep the pallets in closed area.