

INT

fuma[®] - Bautec

// STRONG PARTNER. STRONG PROFILE.

STILL VALID

IN 2026

// COMPLETE SOLUTIONS

FOR TILE INSTALLATION

2025



"Highest product quality and strong partnerships are the basis of our success – this will also be our motivation for the future."

**MICHAEL DEMETER &
HÜSEYİN AKIN**

Managing directors fuma-Bautec

// ADDRESS

Carl-Benz-Straße 9
59348 Lüdinghausen
Germany

Tel. +49 2591 947480
Fax +49 2591 9474850

kontakt@fuma-bautec.com
www.fuma-bautec.com

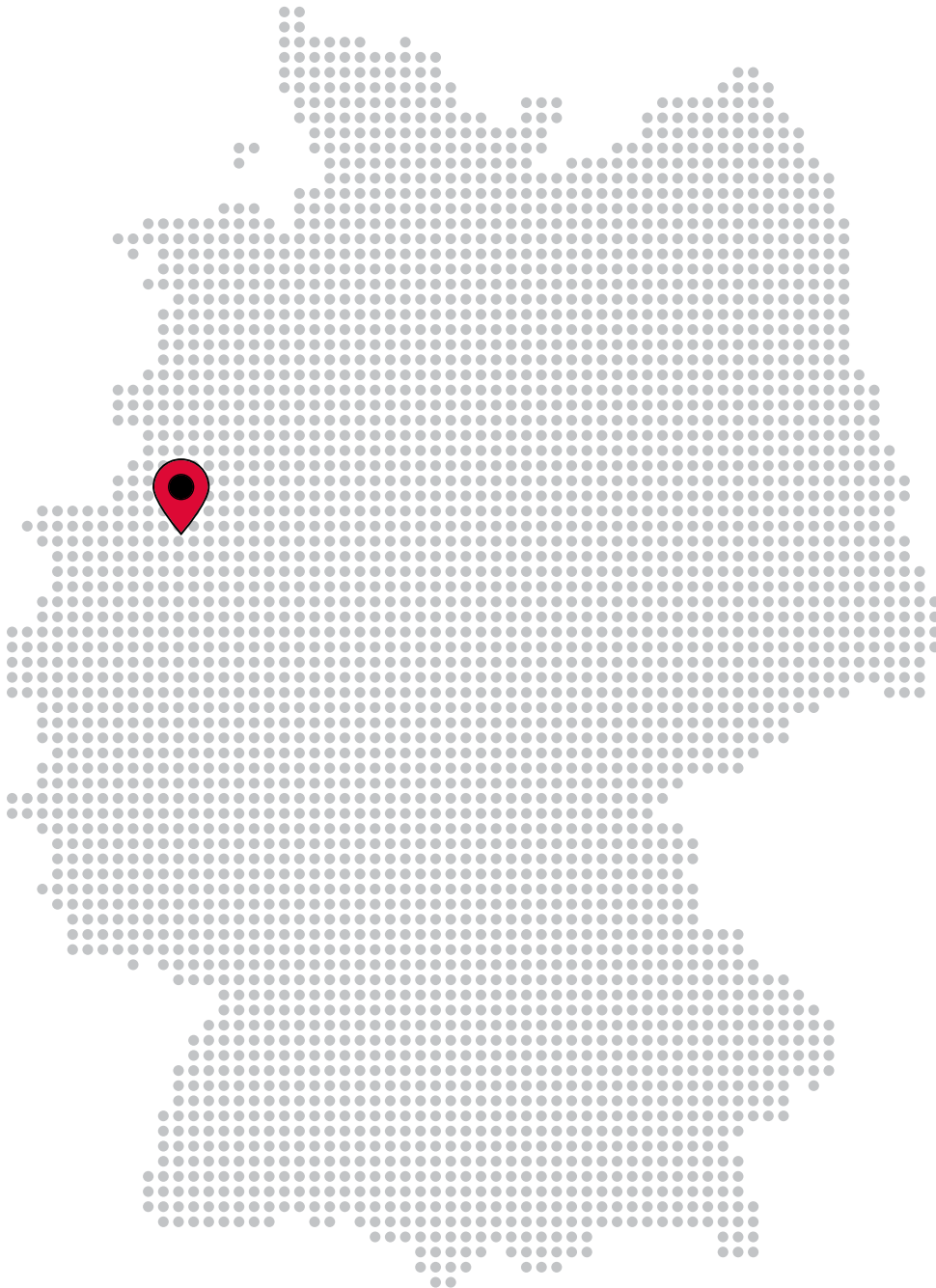

// BUSINESS HOURS

Monday - Friday:
8:00 AM - 5:00 PM
(continuous)



Do you have any questions?

Please use the live chat
feature on our homepage
during our opening hours!



TILE PROFILES		8 - 55
fuma // CLASSIC	L-shaped edging profiles	10 - 20
fuma // CURVE	Bendable edging pro	21
fuma // QUAD	Square edge profiles	22 - 31
fuma // ROUND	Round edge profiles	32 - 47
fuma // ROND	Round profiles	47
fuma // DECO	Decorative border profiles	48
fuma // MITER	Triangular edge profiles	49
fuma // LISTELL	Separating decorative profiles	50 - 51
fuma // T	Separation and cover profiles	52
fuma // COVE	Cove profiles	53 - 55



STAIR-NOSING PROFILES / TRANSITION PROFILES		56 - 65
fuma // STEP	Stair-nosing profiles	58 - 63
fuma // LEVEL	Transition and compensation profiles	64
fuma // BRIDGE	Transition profiles	65



SKIRTING PROFILES		66 - 69
fuma // BASE	Skirting profiles	68 - 69



CORNER PROTECTION PROFILES		70 - 73
fuma // PROTECT	Corner protection profiles	72 - 73

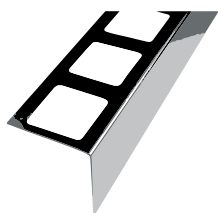

BALCONY PROFILES / TILE SPACERS / PEDESTAL BEARINGS		74 - 81
fuma // OUTDOOR	Balcony profiles	76 - 78
	Gravel bed angle profiles	79
	Gravel bed bearing/Tile spacers	80
	Plate/Terrace bearings	81
	Terrace/Balcony pedestal bearing	81

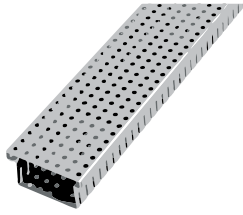

DRAINAGE CHANNELS

82 - 97

fuma // CHANNEL	Drainage channels	84 - 91
	Line drainage channels	92 - 93
	Drainage gullies	94 - 95
	Gravel stop edge profiles	96 - 97



EXPANSION JOINT PROFILES

98 - 113

fuma // MOVE	Thin-bed profiles	100 - 102
	Thick-bed profiles	103 - 104
	Field limitation joint profiles	105
	Cover profiles	105
	Structural expansion joint profiles	106 - 111
	Sports floor profiles	112 - 113



LED PROFILES

114 - 117

fuma // LIGHT	LED decorative profiles	116 - 117
	LED skirting profiles	117

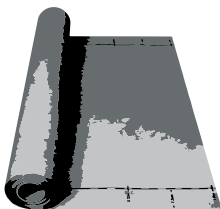

SEALING / DECOUPLING

118 - 127

fuma // SEAL	Waterproofing membrane and accessories	120
	Sealing tapes and accessories	121 - 122
	Liquid sealing	123
	Sealing and drainage for outdoor use	124 - 125
fuma // DEC	Decoupling	126 - 127
	Decoupling and impact sound	127



SHOWER / BATHROOM

128 - 149

fuma // DRAIN	Wall slope profiles	130
	Floor slope profiles/3D corners	131 - 132
	Slope profiles/Edging profiles	133 - 135
	Shower channels	136 - 139
	Bath drains	140 - 141
	Shower boards	142 - 143
fuma // WALL	Shower shelves	144 - 145
	Shower shelves retrofitting possible	146 - 148
	Stainless steel niches	149

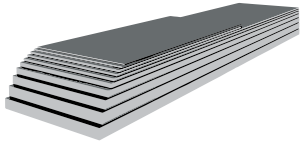

CONSTRUCTION BOARDS

150 - 153

fuma // CON	Construction boards/Angle elements and accessories.....	152 - 153
	Fibreglass and armoring mesh.....	153

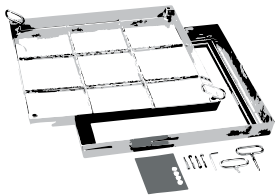

ACCESS COVERS / ADHESIVE FRAMES / INSPECTION DOORS

154 - 161

fuma // COVER	Access covers.....	156 - 159
	Adhesive frames.....	160
	Tile frame.....	161
	Inspection doors.....	161



SWIMMING POOL GRATINGS

162 - 165

fuma // POOL	Transverse, longitudinal version.....	164
	Rigid design, molded parts.....	165
	Accessories.....	165

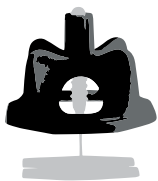

ACCESSORIES

166 - 175

fuma // TOOL	Diamond discs/Diamond core bits.....	168 - 169
	Levelling system.....	170 - 171
	Otto Chemistry silicone.....	172 - 173
	Silicone color overview.....	174 - 175



SALES PROMOTION

176 - 180

fuma // PROMOTION	Sales promotion.....	178 - 180
--------------------------	----------------------	-----------

INFORMATION

182

fuma // INFO	Maintenance for tile profiles.....	182
---------------------	------------------------------------	-----

// COMPREHENSIVE SOLUTIONS UNDER ONE ROOF

Explore our versatile selection of comprehensive tiling solutions – meticulously customized for the entire structure. Whether for interior or exterior applications, our products provide seamless compatibility and top-notch quality. You will discover all your necessities with us – sourced from a single provider for all your needs.

fuma®-Bautec

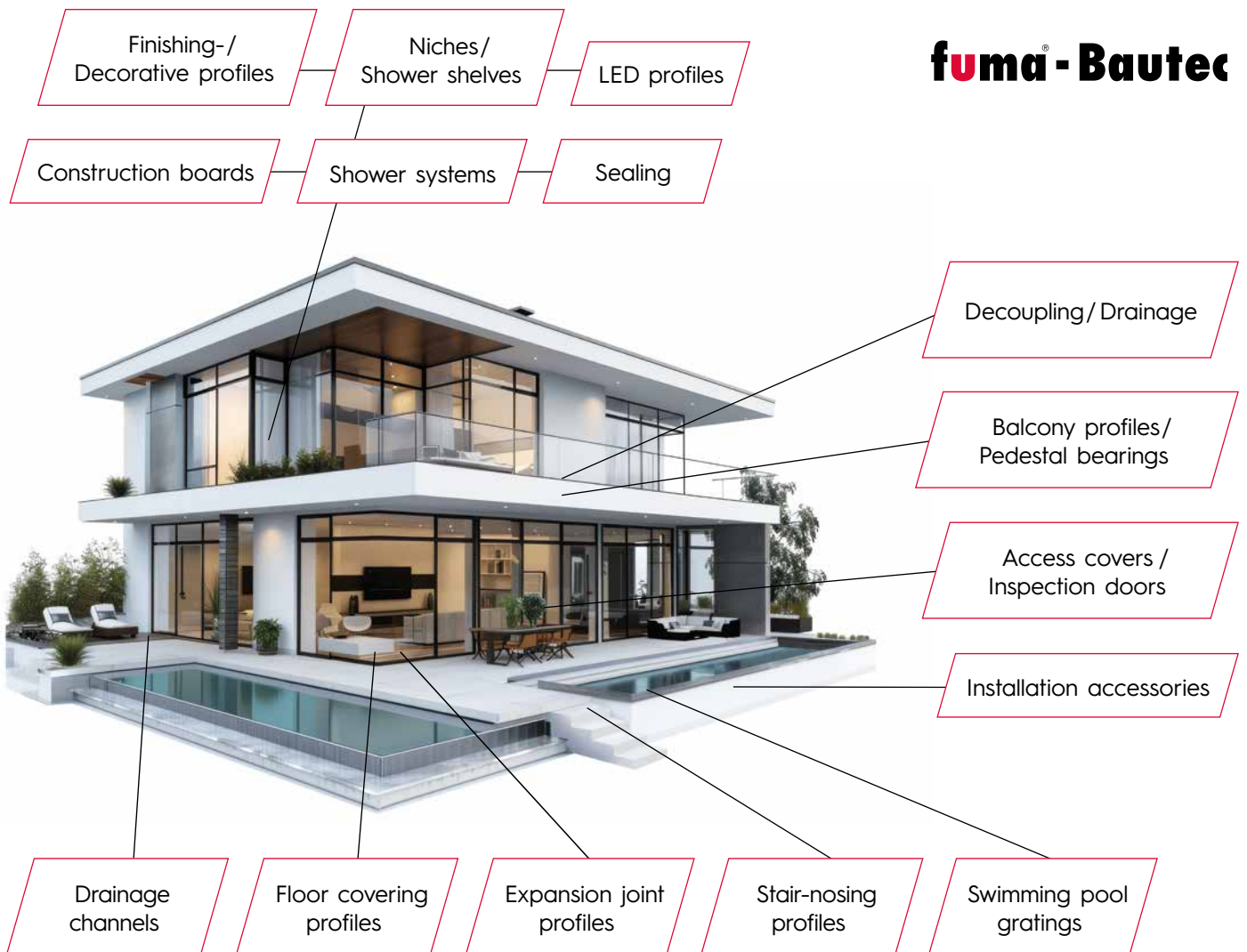





"Tile profiles are our centerpiece. We have been producing high-quality profiles in various shapes, colors and surfaces for decades. They not only protect the edges of the tiles, but also look great."

INGO BECK

part of the fuma-Bautec team
since 2009

fuma // CLASSIC - L-SHAPED EDGING PROFILES
 Stainless steel 1.4301 / 304

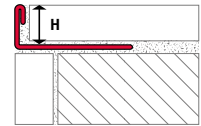

Length: 2.50 m

Height in mm	Item no.
2.0	FEA 020-250
3.0	FEA 030-250
4.5	FEA 045-250
6.0	FEA 060-250
8.0	FEA 080-250
9.0	FEA 090-250
10.0	FEA 100-250
11.0	FEA 110-250
12.5	FEA 125-250
15.0	FEA 150-250
17.0	FEA 170-250
20.0	FEA 200-250
22.0	FEA 220-250
25.0	FEA 250-250
30.0	FEA 300-250

Length: 3.00 m

Height in mm	Item no.
-	-
-	-
-	-
6.0	FEA 060-300
8.0	FEA 080-300
9.0	FEA 090-300
10.0	FEA 100-300
11.0	FEA 110-300
12.5	FEA 125-300
15.0	FEA 150-300
17.0	FEA 170-300
20.0	FEA 200-300
22.0	FEA 220-300
25.0	FEA 250-300
30.0	FEA 300-300

glossy



Length: 2.50 m

Height in mm	Item no.
3.0	FEAS 030-250
4.5	FEAS 045-250
6.0	FEAS 060-250
8.0	FEAS 080-250
9.0	FEAS 090-250
10.0	FEAS 100-250
11.0	FEAS 110-250
12.5	FEAS 125-250
15.0	FEAS 150-250
17.0	FEAS 170-250
20.0	FEAS 200-250
22.0	FEAS 220-250
25.0	FEAS 250-250
30.0	FEAS 300-250

Length: 3.00 m

Height in mm	Item no.
-	-
-	-
6.0	FEAS 060-300
8.0	FEAS 080-300
9.0	FEAS 090-300
10.0	FEAS 100-300
11.0	FEAS 110-300
12.5	FEAS 125-300
15.0	FEAS 150-300
17.0	FEAS 170-300
20.0	FEAS 200-300
22.0	FEAS 220-300
25.0	FEAS 250-300
30.0	FEAS 300-300

brushed



→ More surfaces on the next page.

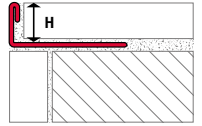

fuma // CLASSIC – L-SHAPED EDGING PROFILES
Stainless steel 1.4301 / 304

Length: 2.50 m

Height in mm	Item no.
8.0	FEAC 080-250
10.0	FEAC 100-250
12.5	FEAC 125-250

chrome
glossy



Length: 2.50 m

Height in mm	Item no.
8.0	FEACS 080-250
10.0	FEACS 100-250
12.5	FEACS 125-250

black
glossy



Length: 2.50 m

Height in mm	Item no.
8.0	FEACG 080-250
10.0	FEACG 100-250
12.5	FEACG 125-250

gold
glossy

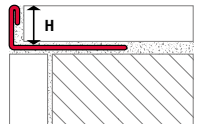

fuma // CLASSIC – L-SHAPED EDGING PROFILES
Stainless steel 1.4404 / 316L

316L

Length: 2.50 m

Height in mm	Item no.
8.0	FEA 080-V4A-250
10.0	FEA 100-V4A-250
12.5	FEA 125-V4A-250

glossy



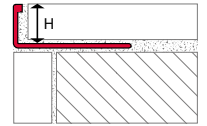

fuma // CLASSIC – L-SHAPED EDGING PROFILES
Aluminum

Length: 2.50 m

Height in mm	Item no.
8.0	FAAC 080-250
10.0	FAAC 100-250
12.5	FAAC 125-250

silver
high-gloss
anodized



Length: 2.50 m

Height in mm	Item no.
8.0	FAHS 080-250
10.0	FAHS 100-250
12.5	FAHS 125-250

silver
high-gloss
anodized
brushed



Length: 2.50 m

Height in mm	Item no.
8.0	FAAT 080-250
10.0	FAAT 100-250
12.5	FAAT 125-250

titanium
anodized



Length: 2.50 m

Height in mm	Item no.
8.0	FATH 080-250
10.0	FATH 100-250
12.5	FATH 125-250

titanium
high-gloss
anodized



Length: 2.50 m

Height in mm	Item no.
8.0	FATS 080-250
10.0	FATS 100-250
12.5	FATS 125-250

titanium
high-gloss
anodized
brushed



Length: 2.50 m

Height in mm	Item no.
8.0	FAAE 080-M-250
10.0	FAAE 100-M-250
12.5	FAAE 125-M-250

brass
anodized



→ More surfaces
on the next page.

fuma // CLASSIC - L-SHAPED EDGING PROFILES

Aluminum

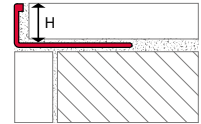

Length: 2.50 m

Height in mm	Item no.
8.0	FAAE 080-SWG-250
10.0	FAAE 100-SWG-250
12.5	FAAE 125-SWG-250

black
high-gloss
anodized



Length: 2.50 m

Height in mm	Item no.
8.0	FAAE 080-SWS-250
10.0	FAAE 100-SWS-250
12.5	FAAE 125-SWS-250

black
high-gloss
anodized
brushed



Length: 2.50 m

Height in mm	Item no.
8.0	FAAE 080-BS-250
10.0	FAAE 100-BS-250
12.5	FAAE 125-BS-250

bronze
anodized
brushed



Length: 2.50 m

Height in mm	Item no.
8.0	FAAE 080-KGS-250
10.0	FAAE 100-KGS-250
12.5	FAAE 125-KGS-250

copper
high-gloss
anodized
brushed



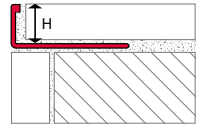

fuma // CLASSIC – L-SHAPED EDGING PROFILES
 Aluminum color coated

Length: 2.50 m

Height in mm	Item no.
6.0	FAAP 060-BW-250
8.0	FAAP 080-BW-250
10.0	FAAP 100-BW-250
11.0	FAAP 110-BW-250
12.5	FAAP 125-BW-250

Length: 2.70 m

Height in mm	Item no.
6.0	FAAP 060-BW-270
8.0	FAAP 080-BW-270
10.0	FAAP 100-BW-270
11.0	FAAP 110-BW-270
12.5	FAAP 125-BW-270

brilliant white



Length: 2.50 m

Height in mm	Item no.
6.0	FAAP 060-BB-250
8.0	FAAP 080-BB-250
10.0	FAAP 100-BB-250
12.5	FAAP 125-BB-250

bahamabeige



Length: 2.50 m

Height in mm	Item no.
6.0	FAAP 060-SW-250
8.0	FAAP 080-SW-250
10.0	FAAP 100-SW-250
11.0	FAAP 110-SW-250
12.5	FAAP 125-SW-250

black matt



Length: 2.50 m

Height in mm	Item no.
6.0	FAAP 060-SGL-250
8.0	FAAP 080-SGL-250
10.0	FAAP 100-SGL-250
11.0	FAAP 110-SGL-250
12.5	FAAP 125-SGL-250

black



Length: 2.50 m

Height in mm	Item no.
6.0	FAAP 060-SG-250
8.0	FAAP 080-SG-250
10.0	FAAP 100-SG-250
12.5	FAAP 125-SG-250

silver grey
(light grey)



→ More surfaces
on the next page.

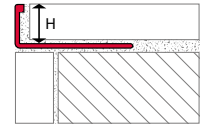

fuma // CLASSIC - L-SHAPED EDGING PROFILES

Aluminum color coated

Length: 2.50 m

Height in mm	Item no.
8.0	FAAP 080-CA-250
10.0	FAAP 100-CA-250
12.5	FAAP 125-CA-250

caramel

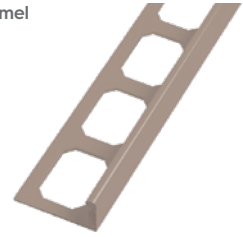

Length: 2.50 m

Height in mm	Item no.
8.0	FAAP 080-AG-250
10.0	FAAP 100-AG-250
12.5	FAAP 125-AG-250

ash grey



Length: 2.50 m

Height in mm	Item no.
8.0	FAAP 080-MHG-250
10.0	FAAP 100-MHG-250
12.5	FAAP 125-MHG-250

manhattan grey



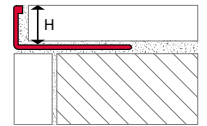

fuma // CLASSIC – L-SHAPED EDGING PROFILES
 Aluminum texture coated

Length: 2.50 m

Height in mm	Item no.
8.0	FAAP 080-GM-250
10.0	FAAP 100-GM-250
11.0	FAAP 110-GM-250
12.5	FAAP 125-GM-250



grey metallic

Length: 2.50 m

Height in mm	Item no.
8.0	FAAP 080-AT-250
10.0	FAAP 100-AT-250
11.0	FAAP 110-AT-250
12.5	FAAP 125-AT-250



anthracite

Length: 2.50 m

Height in mm	Item no.
8.0	FAAP 080-TB-250
10.0	FAAP 100-TB-250
11.0	FAAP 110-TB-250
12.5	FAAP 125-TB-250



terra brown

Length: 2.50 m

Height in mm	Item no.
8.0	FAAP 080-UB-250
10.0	FAAP 100-UB-250
11.0	FAAP 110-UB-250
12.5	FAAP 125-UB-250



umbra

Length: 2.50 m

Height in mm	Item no.
8.0	FAAP 080-QZ-250
10.0	FAAP 100-QZ-250
11.0	FAAP 110-QZ-250
12.5	FAAP 125-QZ-250



quarz

Length: 2.50 m

Height in mm	Item no.
8.0	FAAP 080-SD-250
10.0	FAAP 100-SD-250
11.0	FAAP 110-SD-250
12.5	FAAP 125-SD-250



sand

→ More surfaces on the next page.

fuma // CLASSIC - L-SHAPED EDGING PROFILES
 Aluminum texture coated

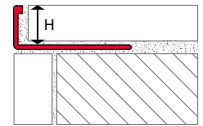

Length: 2.50 m

Height in mm	Item no.
8.0	FAAP 080-DL-250
10.0	FAAP 100-DL-250
11.0	FAAP 110-DL-250
12.5	FAAP 125-DL-250

dolomite



Length: 2.50 m

Height in mm	Item no.
8.0	FAAP 080-ARC-250
10.0	FAAP 100-ARC-250
12.5	FAAP 125-ARC-250

arctic



Length: 2.50 m

Height in mm	Item no.
8.0	FAAP 080-KRD-250
10.0	FAAP 100-KRD-250
12.5	FAAP 125-KRD-250

chalk

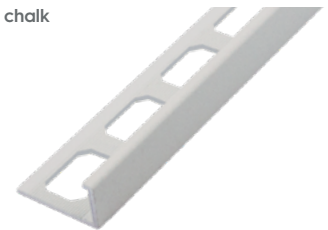

Length: 2.50 m

Height in mm	Item no.
8.0	FAAP 080-CR-250
10.0	FAAP 100-CR-250
12.5	FAAP 125-CR-250

creme



Length: 2.50 m

Height in mm	Item no.
8.0	FAAP 080-MSW-250
10.0	FAAP 100-MSW-250
12.5	FAAP 125-MSW-250

black



Length: 2.50 m

Height in mm	Item no.
8.0	FAAP 080-SWB-250
10.0	FAAP 100-SWB-250
12.5	FAAP 125-SWB-250

black brilliant



→ More surfaces on the next page.

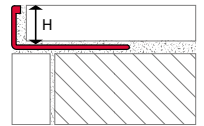

fuma // CLASSIC – L-SHAPED EDGING PROFILES
Aluminum texture coated

Length: 2.50 m

Height in mm	Item no.
8.0	FAAP 080-ATB-250
10.0	FAAP 100-ATB-250
12.5	FAAP 125-ATB-250

Length: 2.50 m

Height in mm	Item no.
8.0	FAAP 080-SGB-250
10.0	FAAP 100-SGB-250
12.5	FAAP 125-SGB-250

Length: 2.50 m

Height in mm	Item no.
8.0	FAAP 080-BGB-250
10.0	FAAP 100-BGB-250
12.5	FAAP 125-BGB-250

Length: 2.50 m

Height in mm	Item no.
8.0	FAAP 080-WB-250
10.0	FAAP 100-WB-250
12.5	FAAP 125-WB-250

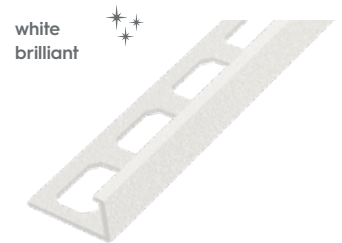

fuma // CLASSIC – L-SHAPED EDGING PROFILES
Brass

Length: 2.50 m

Height in mm	Item no.
6.0	FMA 060-250
8.0	FMA 080-250
10.0	FMA 100-250
12.5	FMA 125-250
15.0	FMA 150-250
20.0	FMA 200-250



fuma // CLASSIC - L-SHAPED EDGING PROFILES
PVC

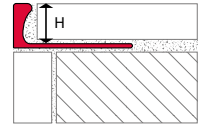

Length: 2.50 m

Height in mm	Item no.
6.0	FPA 060-BW-250
8.0	FPA 080-BW-250
10.0	FPA 100-BW-250
11.0	FPA 110-BW-250
12.5	FPA 125-BW-250

Length: 2.70 m

Height in mm	Item no.
6.0	FPA 060-BW-270
8.0	FPA 080-BW-270
10.0	FPA 100-BW-270
-	-
12.5	FPA 125-BW-270

Length: 3.00 m

Height in mm	Item no.
6.0	FPA 060-BW-300
8.0	FPA 080-BW-300
10.0	FPA 100-BW-300
11.0	FPA 110-BW-300
12.5	FPA 125-BW-300

brilliant white



Length: 2.50 m

Height in mm	Item no.
6.0	FPA 060-AW-250
8.0	FPA 080-AW-250
10.0	FPA 100-AW-250
12.5	FPA 125-AW-250

Length: 2.70 m

Height in mm	Item no.
6.0	FPA 060-AW-270
8.0	FPA 080-AW-270
10.0	FPA 100-AW-270
12.5	FPA 125-AW-270

Length: 3.00 m

Height in mm	Item no.
6.0	FPA 060-AW-300
8.0	FPA 080-AW-300
10.0	FPA 100-AW-300
12.5	FPA 125-AW-300

off-white (jasmine)

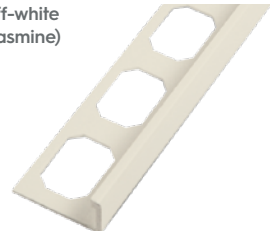

Length: 2.50 m

Height in mm	Item no.
6.0	FPA 060-SG-250
8.0	FPA 080-SG-250
10.0	FPA 100-SG-250
12.5	FPA 125-SG-250

silver grey



Length: 2.50 m

Height in mm	Item no.
6.0	FPA 060-PG-250
8.0	FPA 080-PG-250
10.0	FPA 100-PG-250
12.5	FPA 125-PG-250

pergamon



Length: 2.50 m

Height in mm	Item no.
6.0	FPA 060-CA-250
8.0	FPA 080-CA-250
10.0	FPA 100-CA-250
12.5	FPA 125-CA-250

caramel



Length: 2.50 m

Height in mm	Item no.
8.0	FPA 080-SW-250
10.0	FPA 100-SW-250
12.5	FPA 125-SW-250

black



fuma // CURVE – BENDABLE EDGING PROFILES
Stainless steel 1.4301 / 304

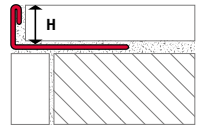

Length: 2.50 m

Height in mm	Item no.
3.0	FEA 030/R-250
4.5	FEA 045/R-250
6.0	FEA 060/R-250
8.0	FEA 080/R-250
10.0	FEA 100/R-250
11.0	FEA 110/R-250
12.5	FEA 125/R-250
15.0	FEA 150/R-250
17.0	FEA 170/R-250



fuma // CURVE – BENDABLE EDGING PROFILES
Aluminum

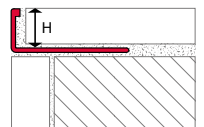

Length: 2.50 m

Height in mm	Item no.
2.0	FAA 020/R-250
3.0	FAA 030/R-250
4.5	FAA 045/R-250
6.0	FAA 060/R-250
8.0	FAA 080/R-250
10.0	FAA 100/R-250
12.5	FAA 125/R-250
15.0	FAA 150/R-250
18.5	FAA 185/R-250
20.0	FAA 200/R-250
22.0	FAA 220/R-250
25.0	FAA 250/R-250
30.0	FAA 300/R-250



Length: 2.50 m

Height in mm	Item no.
2.0	FAAE 020/R-250
3.0	FAAE 030/R-250
4.5	FAAE 045/R-250
6.0	FAAE 060/R-250
8.0	FAAE 080/R-250
10.0	FAAE 100/R-250
12.5	FAAE 125/R-250
15.0	FAAE 150/R-250

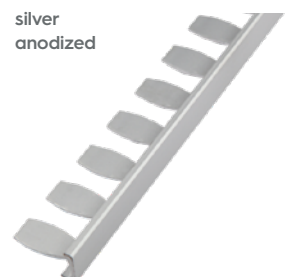

fuma // QUAD – SQUARE EDGE PROFILES
Stainless steel 1.4301 / 304, with corner pieces

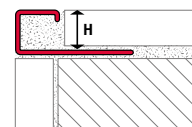

Length: 2.50 m

Height in mm	Item no.
7.0	FQEP 070-250
8.0	FQEP 080-250
9.0	FQEP 090-250
10.0	FQEP 100-250
11.0	FQEP 110-250
12.5	FQEP 125-250

Length: 3.00 m

Height in mm	Item no.
7.0	FQEP 070-300
8.0	FQEP 080-300
9.0	FQEP 090-300
10.0	FQEP 100-300
11.0	FQEP 110-300
12.5	FQEP 125-300

glossy



Square edge corner pieces*

Height in mm	Item no.
7.0	E-FQEP 070
8.0	E-FQEP 080
9.0	E-FQEP 090
10.0	E-FQEP 100
11.0	E-FQEP 110
12.5	E-FQEP 125

Square edge corner pieces* - Metal die-cast

Height in mm	Item no.
-	-
-	-
9.0	E-FQIP 090
10.0	E-FQIP 100
11.0	E-FQIP 110
12.5	E-FQIP 125



Length: 2.50 m

Height in mm	Item no.
7.0	FQES 070-250
8.0	FQES 080-250
9.0	FQES 090-250
10.0	FQES 100-250
11.0	FQES 110-250
12.5	FQES 125-250

Length: 3.00 m

Height in mm	Item no.
7.0	FQES 070-300
8.0	FQES 080-300
9.0	FQES 090-300
10.0	FQES 100-300
11.0	FQES 110-300
12.5	FQES 125-300

brushed



Square edge corner pieces*

Height in mm	Item no.
7.0	E-FQES 070
8.0	E-FQES 080
9.0	E-FQES 090
10.0	E-FQES 100
11.0	E-FQES 110
12.5	E-FQES 125

Square edge corner pieces* - Metal die-cast

Height in mm	Item no.
-	-
-	-
9.0	E-FQIS 090
10.0	E-FQIS 100
11.0	E-FQIS 110
12.5	E-FQIS 125



→ More surfaces on the next page.

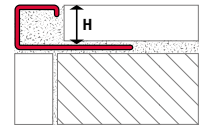

fuma // QUAD – SQUARE EDGE PROFILES
 Stainless steel 1.4301/304, with corner pieces

Length: 2.50 m

Height in mm	Item no.
8.0	FQEC 080-250
10.0	FQEC 100-250
12.5	FQEC 125-250

Square edge corner pieces*

Height in mm	Item no.
8.0	E-FQEC 080
10.0	E-FQEC 100
12.5	E-FQEC 125

chrome glossy



Length: 2.50 m

Height in mm	Item no.
8.0	FQECS 080-250
10.0	FQECS 100-250
12.5	FQECS 125-250

Square edge corner pieces*

Height in mm	Item no.
8.0	E-FQECS 080
10.0	E-FQECS 100
12.5	E-FQECS 125

black glossy



Length: 2.50 m

Height in mm	Item no.
8.0	FQECCG 080-250
10.0	FQECCG 100-250
12.5	FQECCG 125-250

Square edge corner pieces*

Height in mm	Item no.
8.0	E-FQECCG 080
10.0	E-FQECCG 100
12.5	E-FQECCG 125

gold glossy



fuma // QUAD – SQUARE EDGE PROFILES
 Aluminum, with corner pieces

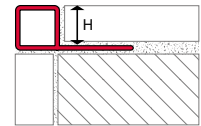

Length: 2.50 m

Height in mm	Item no.
7.0	FQAS 070-250
8.0	FQAS 080-250
9.0	FQAS 090-250
10.0	FQAS 100-250
12.5	FQAS 125-250

Square edge corner pieces*

Height in mm	Item no.
7.0	E-FQAS 070
8.0	E-FQAS 080
9.0	E-FQAS 090
10.0	E-FQAS 100
12.5	E-FQAS 125

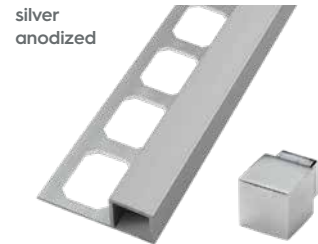

Length: 2.50 m

Height in mm	Item no.
7.0	FQSG 070-250
8.0	FQSG 080-250
9.0	FQSG 090-250
10.0	FQSG 100-250
12.5	FQSG 125-250

Square edge corner pieces*

Height in mm	Item no.
7.0	E-FQSG 070
8.0	E-FQSG 080
9.0	E-FQSG 090
10.0	E-FQSG 100
12.5	E-FQSG 125



Length: 2.50 m

Height in mm	Item no.
7.0	FQHS 070-250
8.0	FQHS 080-250
9.0	FQHS 090-250
10.0	FQHS 100-250
12.5	FQHS 125-250

Square edge corner pieces*

Height in mm	Item no.
7.0	E-FQHS 070
8.0	E-FQHS 080
9.0	E-FQHS 090
10.0	E-FQHS 100
12.5	E-FQHS 125

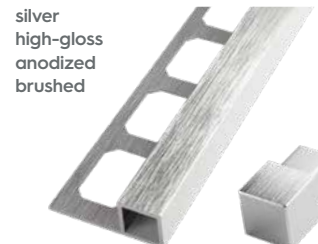

Length: 2.50 m

Height in mm	Item no.
-	-
8.0	FQT 080-250
9.0	FQT 090-250
10.0	FQT 100-250
12.5	FQT 125-250

Square edge corner pieces*

Height in mm	Item no.
-	-
8.0	E-FQT 080
9.0	E-FQT 090
10.0	E-FQT 100
12.5	E-FQT 125



Length: 2.50 m

Height in mm	Item no.
7.0	FQTH 070-250
8.0	FQTH 080-250
9.0	FQTH 090-250
10.0	FQTH 100-250
12.5	FQTH 125-250

Square edge corner pieces*

Height in mm	Item no.
7.0	E-FQTH 070
8.0	E-FQTH 080
9.0	E-FQTH 090
10.0	E-FQTH 100
12.5	E-FQTH 125

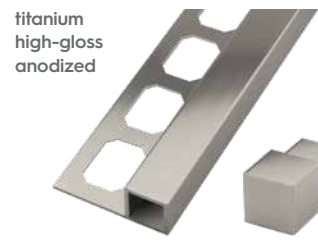

→ More surfaces on the next page.

* All corner pieces can be used both as internal and external corners.

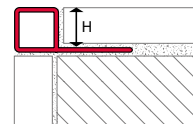

fuma // QUAD – SQUARE EDGE PROFILES

Aluminum, with corner pieces

Length: 2.50 m

Height in mm	Item no.
7.0	FQTS 070-250
8.0	FQTS 080-250
9.0	FQTS 090-250
10.0	FQTS 100-250
12.5	FQTS 125-250

Square edge corner pieces*

Height in mm	Item no.
7.0	E-FQTS 070
8.0	E-FQTS 080
9.0	E-FQTS 090
10.0	E-FQTS 100
12.5	E-FQTS 125

titanium
high-gloss
anodized
brushed



Length: 2.50 m

Height in mm	Item no.
10.0	FQAE 100-SWG-250
12.5	FQAE 125-SWG-250

Square edge corner pieces*

Height in mm	Item no.
10.0	E-FQAE 100-SWG
12.5	E-FQAE 125-SWG

black
high-gloss
anodized

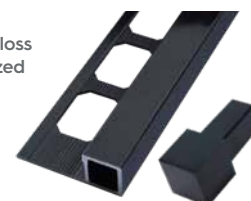

Length: 2.50 m

Height in mm	Item no.
10.0	FQAE 100-SWS-250
12.5	FQAE 125-SWS-250

Square edge corner pieces*

Height in mm	Item no.
10.0	E-FQAE 100-SWS
12.5	E-FQAE 125-SWS

black
high-gloss
anodized
brushed



Length: 2.50 m

Height in mm	Item no.
10.0	FQAE 100-BS-250
12.5	FQAE 125-BS-250

Square edge corner pieces*

Height in mm	Item no.
10.0	E-FQAE 100-BS
12.5	E-FQAE 125-BS

bronze
anodized
brushed

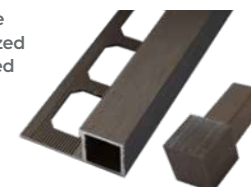

Length: 2.50 m

Height in mm	Item no.
10.0	FQAE 100-KGS-250
12.5	FQAE 125-KGS-250

Square edge corner pieces*

Height in mm	Item no.
10.0	E-FQAE 100-KGS
12.5	E-FQAE 125-KGS

copper
high-gloss
anodized
brushed

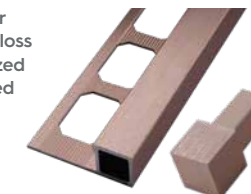

fuma // QUAD – SQUARE EDGE PROFILES
 Aluminum color coated, with corner pieces

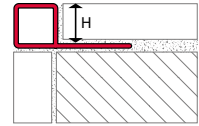

Length: 2.50 m

Height in mm	Item no.
8.0	FQPS 080-SW-250
10.0	FQPS 100-SW-250
11.0	FQPS 110-SW-250
12.5	FQPS 125-SW-250

Square edge corner pieces*

Height in mm	Item no.
8.0	E-FQPS 080-SW
10.0	E-FQPS 100-SW
11.0	E-FQPS 110-SW
12.5	E-FQPS 125-SW

black matt
RAL 9005



Length: 2.50 m

Height in mm	Item no.
8.0	FQPS 080-CA-250
10.0	FQPS 100-CA-250
11.0	FQPS 110-CA-250
12.5	FQPS 125-CA-250

Square edge corner pieces*

Height in mm	Item no.
8.0	E-FQPS 080-CA
10.0	E-FQPS 100-CA
11.0	E-FQPS 110-CA
12.5	E-FQPS 125-CA

caramel

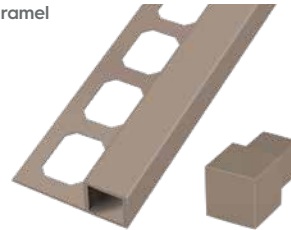

Length: 2.50 m

Height in mm	Item no.
8.0	FQPS 080-AG-250
10.0	FQPS 100-AG-250
11.0	FQPS 110-AG-250
12.5	FQPS 125-AG-250

Square edge corner pieces*

Height in mm	Item no.
8.0	E-FQPS 080-AG
10.0	E-FQPS 100-AG
11.0	E-FQPS 110-AG
12.5	E-FQPS 125-AG

ash grey

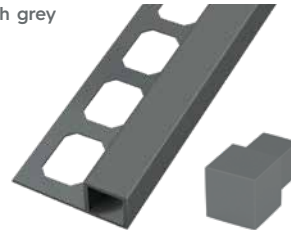

Length: 2.50 m

Height in mm	Item no.
8.0	FQPS 080-MHG-250
10.0	FQPS 100-MHG-250
11.0	FQPS 110-MHG-250
12.5	FQPS 125-MHG-250

Square edge corner pieces*

Height in mm	Item no.
8.0	E-FQPS 080-MHG
10.0	E-FQPS 100-MHG
11.0	E-FQPS 110-MHG
12.5	E-FQPS 125-MHG

manhattan
grey

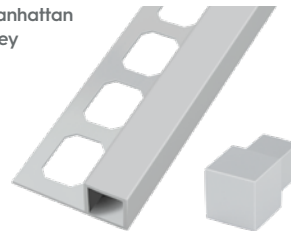

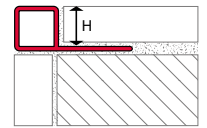

fuma // QUAD – SQUARE EDGE PROFILES
 Aluminum texture coated, with corner pieces

Length: 2.50 m

Height in mm	Item no.
8.0	FQPS 080-GM-250
10.0	FQPS 100-GM-250
11.0	FQPS 110-GM-250
12.5	FQPS 125-GM-250

Square edge corner pieces*

Height in mm	Item no.
8.0	E-FQPS 080-GM
10.0	E-FQPS 100-GM
11.0	E-FQPS 110-GM
12.5	E-FQPS 125-GM

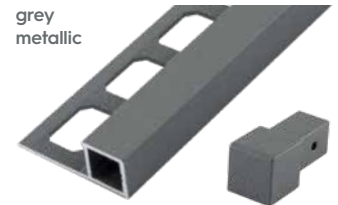

Length: 2.50 m

Height in mm	Item no.
8.0	FQPS 080-AT-250
10.0	FQPS 100-AT-250
11.0	FQPS 110-AT-250
12.5	FQPS 125-AT-250

Square edge corner pieces*

Height in mm	Item no.
8.0	E-FQPS 080-AT
10.0	E-FQPS 100-AT
11.0	E-FQPS 110-AT
12.5	E-FQPS 125-AT

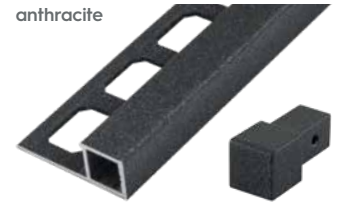

Length: 2.50 m

Height in mm	Item no.
8.0	FQPS 080-TB-250
10.0	FQPS 100-TB-250
11.0	FQPS 110-TB-250
12.5	FQPS 125-TB-250

Square edge corner pieces*

Height in mm	Item no.
8.0	E-FQPS 080-TB
10.0	E-FQPS 100-TB
11.0	E-FQPS 110-TB
12.5	E-FQPS 125-TB

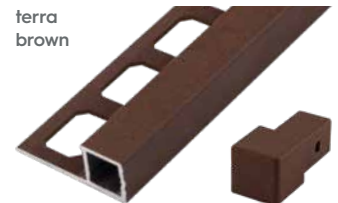

Length: 2.50 m

Height in mm	Item no.
8.0	FQPS 080-UB-250
10.0	FQPS 100-UB-250
11.0	FQPS 110-UB-250
12.5	FQPS 125-UB-250

Square edge corner pieces*

Height in mm	Item no.
8.0	E-FQPS 080-UB
10.0	E-FQPS 100-UB
11.0	E-FQPS 110-UB
12.5	E-FQPS 125-UB

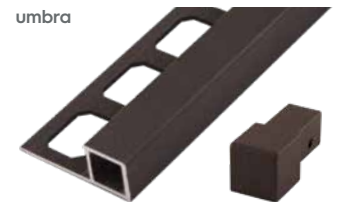

Length: 2.50 m

Height in mm	Item no.
8.0	FQPS 080-QZ-250
10.0	FQPS 100-QZ-250
11.0	FQPS 110-QZ-250
12.5	FQPS 125-QZ-250

Square edge corner pieces*

Height in mm	Item no.
8.0	E-FQPS 080-QZ
10.0	E-FQPS 100-QZ
11.0	E-FQPS 110-QZ
12.5	E-FQPS 125-QZ



Length: 2.50 m

Height in mm	Item no.
8.0	FQPS 080-SD-250
10.0	FQPS 100-SD-250
11.0	FQPS 110-SD-250
12.5	FQPS 125-SD-250

Square edge corner pieces*

Height in mm	Item no.
8.0	E-FQPS 080-SD
10.0	E-FQPS 100-SD
11.0	E-FQPS 110-SD
12.5	E-FQPS 125-SD



→ More surfaces on the next page.

fuma // QUAD – SQUARE EDGE PROFILES
 Aluminum texture coated, with corner pieces

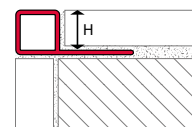

Length: 2.50 m

Height in mm	Item no.
8.0	FQPS 080-DL-250
10.0	FQPS 100-DL-250
11.0	FQPS 110-DL-250
12.5	FQPS 125-DL-250

Square edge corner pieces*

Height in mm	Item no.
8.0	E-FQPS 080-DL
10.0	E-FQPS 100-DL
11.0	E-FQPS 110-DL
12.5	E-FQPS 125-DL



Length: 2.50 m

Height in mm	Item no.
8.0	FQPS 080-ARC-250
10.0	FQPS 100-ARC-250
11.0	FQPS 110-ARC-250
12.5	FQPS 125-ARC-250

Square edge corner pieces*

Height in mm	Item no.
8.0	E-FQPS 080-ARC
10.0	E-FQPS 100-ARC
11.0	E-FQPS 110-ARC
12.5	E-FQPS 125-ARC

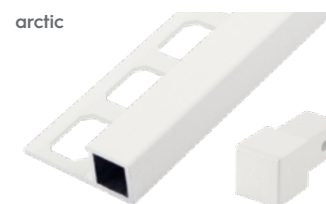

Length: 2.50 m

Height in mm	Item no.
8.0	FQPS 080-KRD-250
10.0	FQPS 100-KRD-250
11.0	FQPS 110-KRD-250
12.5	FQPS 125-KRD-250

Square edge corner pieces*

Height in mm	Item no.
8.0	E-FQPS 080-KRD
10.0	E-FQPS 100-KRD
11.0	E-FQPS 110-KRD
12.5	E-FQPS 125-KRD

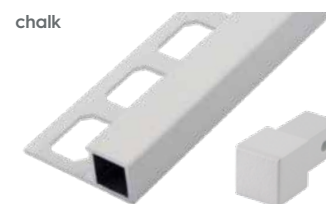

Length: 2.50 m

Height in mm	Item no.
8.0	FQPS 080-CR-250
10.0	FQPS 100-CR-250
11.0	FQPS 110-CR-250
12.5	FQPS 125-CR-250

Square edge corner pieces*

Height in mm	Item no.
8.0	E-FQPS 080-CR
10.0	E-FQPS 100-CR
11.0	E-FQPS 110-CR
12.5	E-FQPS 125-CR

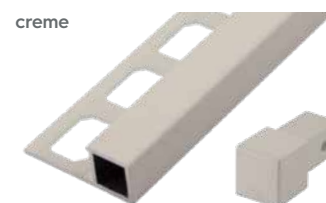

Length: 2.50 m

Height in mm	Item no.
8.0	FQPS 080-MSW-250
10.0	FQPS 100-MSW-250
11.0	FQPS 110-MSW-250
12.5	FQPS 125-MSW-250

Square edge corner pieces*

Height in mm	Item no.
8.0	E-FQPS 080-MSW
10.0	E-FQPS 100-MSW
11.0	E-FQPS 110-MSW
12.5	E-FQPS 125-MSW

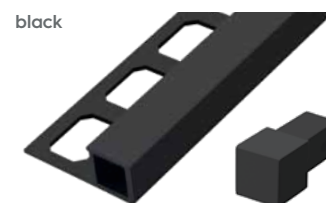

→ More surfaces on the next page.

* All corner pieces can be used both as internal and external corners.

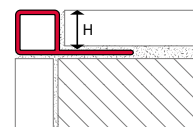

fuma // QUAD - SQUARE EDGE PROFILES
 Aluminum texture coated, with corner pieces

Length: 2.50 m

Height in mm	Item no.
8.0	FQPS 080-SWB-250
10.0	FQPS 100-SWB-250
11.0	FQPS 110-SWB-250
12.5	FQPS 125-SWB-250

Square edge corner pieces*

Height in mm	Item no.
8.0	E-FQPS 080-SWB
10.0	E-FQPS 100-SWB
11.0	E-FQPS 110-SWB
12.5	E-FQPS 125-SWB



Length: 2.50 m

Height in mm	Item no.
8.0	FQPS 080-ATB-250
10.0	FQPS 100-ATB-250
11.0	FQPS 110-ATB-250
12.5	FQPS 125-ATB-250

Square edge corner pieces*

Height in mm	Item no.
8.0	E-FQPS 080-ATB
10.0	E-FQPS 100-ATB
11.0	E-FQPS 110-ATB
12.5	E-FQPS 125-ATB



Length: 2.50 m

Height in mm	Item no.
8.0	FQPS 080-SGB-250
10.0	FQPS 100-SGB-250
11.0	FQPS 110-SGB-250
12.5	FQPS 125-SGB-250

Square edge corner pieces*

Height in mm	Item no.
8.0	E-FQPS 080-SGB
10.0	E-FQPS 100-SGB
11.0	E-FQPS 110-SGB
12.5	E-FQPS 125-SGB



Length: 2.50 m

Height in mm	Item no.
8.0	FQPS 080-BGB-250
10.0	FQPS 100-BGB-250
11.0	FQPS 110-BGB-250
12.5	FQPS 125-BGB-250

Square edge corner pieces*

Height in mm	Item no.
8.0	E-FQPS 080-BGB
10.0	E-FQPS 100-BGB
11.0	E-FQPS 110-BGB
12.5	E-FQPS 125-BGB



Length: 2.50 m

Height in mm	Item no.
8.0	FQPS 080-WB-250
10.0	FQPS 100-WB-250
11.0	FQPS 110-WB-250
12.5	FQPS 125-WB-250

Square edge corner pieces*

Height in mm	Item no.
8.0	E-FQPS 080-WB
10.0	E-FQPS 100-WB
11.0	E-FQPS 110-WB
12.5	E-FQPS 125-WB

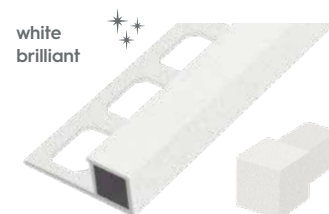

* All corner pieces can be used both as internal and external corners.

fuma // QUAD – SQUARE EDGE PROFILES
 PVC, with corner pieces

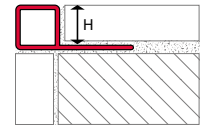

Length: 2.50 m

Height in mm	Item no.
9.0	FQPV 090-BW-250
11.0	FQPV 110-BW-250

Square edge corner pieces*

Height in mm	Item no.
9.0	E-FQPV 090-BW
11.0	E-FQPV 110-BW

brilliant white

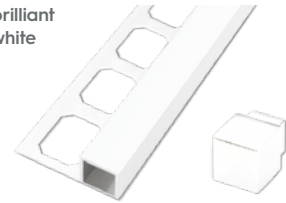

Length: 2.50 m

Height in mm	Item no.
9.0	FQPV 090-AW-250
11.0	FQPV 110-AW-250

Square edge corner pieces*

Height in mm	Item no.
9.0	E-FQPV 090-AW
11.0	E-FQPV 110-AW

off-white (jasmine)

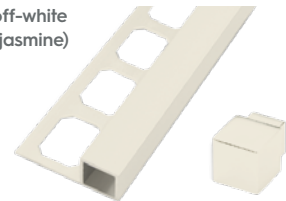

Length: 2.50 m

Height in mm	Item no.
9.0	FQPV 090-SG-250
11.0	FQPV 110-SG-250

Square edge corner pieces*

Height in mm	Item no.
9.0	E-FQPV 090-SG
11.0	E-FQPV 110-SG

silver grey

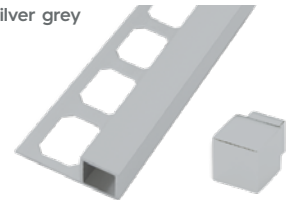

Length: 2.50 m

Height in mm	Item no.
9.0	FQPV 090-SW-250
11.0	FQPV 110-SW-250

Square edge corner pieces*

Height in mm	Item no.
9.0	E-FQPV 090-SW
11.0	E-FQPV 110-SW

black

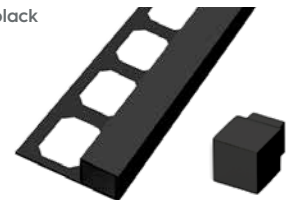

* All corner pieces can be used both as internal and external corners.



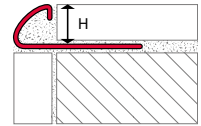

fuma // ROUND – ROUND EDGE PROFILES
Stainless steel 1.4301 / 304, with corner pieces

Length: 2.50 m

Height in mm	Item no.
6.0	FEV 060-250
8.0	FEV 080-250
10.0	FEV 100-250
11.0	FEV 110-250
12.5	FEV 125-250

Length: 3.00 m

Height in mm	Item no.
6.0	FEV 060-300
8.0	FEV 080-300
10.0	FEV 100-300
11.0	FEV 110-300
12.5	FEV 125-300

glossy



External corners

Height in mm	Item no.
6.0	E-FEV 060
8.0	E-FEV 080
10.0	E-FEV 100
11.0	E-FEV 110
12.5	E-FEV 125

Internal corners

Height in mm	Item no.
6.0	I-FEV 060
8.0	I-FEV 080
10.0	I-FEV 100
11.0	I-FEV 110
12.5	I-FEV 125



External corners - Metal die-cast

Height in mm	Item no.
-	-
8.0	E-FIV 080
10.0	E-FIV 100
11.0	E-FIV 110
12.5	E-FIV 125

Internal corners - Metal die-cast

Height in mm	Item no.
-	-
8.0	I-FIV 080
10.0	I-FIV 100
11.0	I-FIV 110
12.5	I-FIV 125

Metal die-cast



Length: 2.50 m

Height in mm	Item no.
6.0	FEVS 060-250
8.0	FEVS 080-250
10.0	FEVS 100-250
11.0	FEVS 110-250
12.5	FEVS 125-250

Length: 3.00 m

Height in mm	Item no.
6.0	FEVS 060-300
8.0	FEVS 080-300
10.0	FEVS 100-300
11.0	FEVS 110-300
12.5	FEVS 125-300

brushed



External corners

Height in mm	Item no.
6.0	E-FEVS 060
8.0	E-FEVS 080
10.0	E-FEVS 100
11.0	E-FEVS 110
12.5	E-FEVS 125

Internal corners

Height in mm	Item no.
6.0	I-FEVS 060
8.0	I-FEVS 080
10.0	I-FEVS 100
11.0	I-FEVS 110
12.5	I-FEVS 125



→ More surfaces on the next page.

fuma // ROUND - ROUND EDGE PROFILES
Stainless steel 1.4301/304, with corner pieces

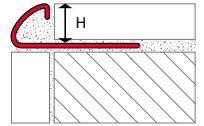

Length: 2.50 m

Height in mm	Item no.
8.0	FEVC 080-250
10.0	FEVC 100-250
11.0	FEVC 110-250
12.5	FEVC 125-250

chrome
glossy



External corners

Height in mm	Item no.
8.0	E-FEVC 080
10.0	E-FEVC 100
11.0	E-FEVC 110
12.5	E-FEVC 125

Internal corners

Height in mm	Item no.
8.0	I-FEVC 080
10.0	I-FEVC 100
11.0	I-FEVC 110
12.5	I-FEVC 125



fuma // ROUND - ROUND EDGE PROFILES
Stainless steel 1.4404/316L, with corner pieces

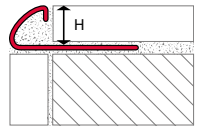

316L

Length: 2.50 m

Height in mm	Item no.
8.0	FEV 080 V4A-250
10.0	FEV 100 V4A-250

glossy



External corners

Height in mm	Item no.
8.0	E-FEV 080 V4A
10.0	E-FEV 100 V4A

Internal corners

Height in mm	Item no.
8.0	I-FEV 080 V4A
10.0	I-FEV 100 V4A



fuma // ROUND – ROUND EDGE PROFILES
 Aluminum, with corner pieces

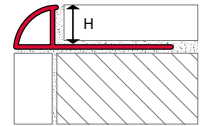

Length: 2.50 m

Height in mm	Item no.
6.0	FVGS 060-250
8.0	FVGS 080-250
10.0	FVGS 100-250
12.5	FVGS 125-250

Length: 3.00 m

Height in mm	Item no.
6.0	FVGS 060-300
8.0	FVGS 080-300
10.0	FVGS 100-300
12.5	FVGS 125-300

silver anodized



External corners

Height in mm	Item no.
6.0	E-FVGS 060
8.0	E-FVGS 080
10.0	E-FVGS 100
12.5	E-FVGS 125

Internal corners

Height in mm	Item no.
6.0	I-FVGS 060
8.0	I-FVGS 080
10.0	I-FVGS 100
12.5	I-FVGS 125



Length: 2.50 m

Height in mm	Item no.
6.0	FVGC 060-250
8.0	FVGC 080-250
10.0	FVGC 100-250
12.5	FVGC 125-250

silver high-gloss anodized



External corners

Height in mm	Item no.
6.0	E-FVGC 060
8.0	E-FVGC 080
10.0	E-FVGC 100
12.5	E-FVGC 125

Internal corners

Height in mm	Item no.
6.0	I-FVGC 060
8.0	I-FVGC 080
10.0	I-FVGC 100
12.5	I-FVGC 125



Length: 2.50 m

Height in mm	Item no.
8.0	FVHS 080-250
10.0	FVHS 100-250
12.5	FVHS 125-250

silver high-gloss anodized brushed



External corners

Height in mm	Item no.
8.0	E-FVHS 080
10.0	E-FVHS 100
12.5	E-FVHS 125

Internal corners

Height in mm	Item no.
8.0	I-FVHS 080
10.0	I-FVHS 100
12.5	I-FVHS 125



→ More surfaces on the next page.

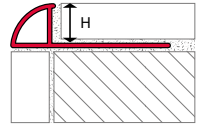

fuma // ROUND - ROUND EDGE PROFILES
 Aluminum, with corner pieces

Length: 2.50 m

Height in mm	Item no.
8.0	FVGT 080-250
10.0	FVGT 100-250
12.5	FVGT 125-250

External corners

Height in mm	Item no.
8.0	E-FVGT 080
10.0	E-FVGT 100
12.5	E-FVGT 125

Internal corners

Height in mm	Item no.
8.0	I-FVGT 080
10.0	I-FVGT 100
12.5	I-FVGT 125

titanium anodized

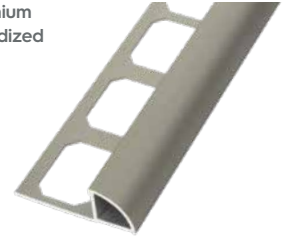

Length: 2.50 m

Height in mm	Item no.
8.0	FVTH 080-250
10.0	FVTH 100-250
12.5	FVTH 125-250

External corners

Height in mm	Item no.
8.0	E-FVTH 080
10.0	E-FVTH 100
12.5	E-FVTH 125

Internal corners

Height in mm	Item no.
8.0	I-FVTH 080
10.0	I-FVTH 100
12.5	I-FVTH 125

titanium high-gloss anodized



Length: 2.50 m

Height in mm	Item no.
8.0	FVTS 080-250
10.0	FVTS 100-250
12.5	FVTS 125-250

External corners

Height in mm	Item no.
8.0	E-FVTS 080
10.0	E-FVTS 100
12.5	E-FVTS 125

Internal corners

Height in mm	Item no.
8.0	I-FVTS 080
10.0	I-FVTS 100
12.5	I-FVTS 125

titanium high-gloss anodized brushed



→ More surfaces on the next page.

fuma // ROUND – ROUND EDGE PROFILES

Aluminum, with corner pieces

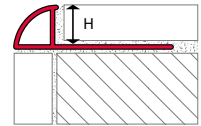

Length: 2.50 m

Height in mm	Item no.
10.0	FVAE 100-M-250
12.5	FVAE 125-M-250

External corners

Height in mm	Item no.
10.0	E-FVAE 100-M
12.5	E-FVAE 125-M

Internal corners

Height in mm	Item no.
10.0	I-FVAE 100-M
12.5	I-FVAE 125-M

brass anodized

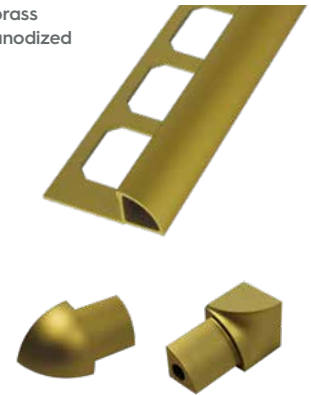

Length: 2.50 m

Height in mm	Item no.
10.0	FVAE 100-SWG-250
12.5	FVAE 125-SWG-250

External corners

Height in mm	Item no.
10.0	E-FVAE 100-SWG
12.5	E-FVAE 125-SWG

Internal corners

Height in mm	Item no.
10.0	I-FVAE 100-SWG
12.5	I-FVAE 125-SWG

black high-gloss anodized



Length: 2.50 m

Height in mm	Item no.
10.0	FVAE 100-SWS-250
12.5	FVAE 125-SWS-250

External corners

Height in mm	Item no.
10.0	E-FVAE 100-SWS
12.5	E-FVAE 125-SWS

Internal corners

Height in mm	Item no.
10.0	I-FVAE 100-SWS
12.5	I-FVAE 125-SWS

black high-gloss anodized brushed



→ More surfaces on the next page.

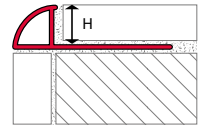

fuma // ROUND - ROUND EDGE PROFILES
 Aluminum, with corner pieces

Length: 2.50 m

Height in mm	Item no.
100	FVAE 100-BS-250
125	FVAE 125-BS-250

External corners

Height in mm	Item no.
100	E-FVAE 100-BS
125	E-FVAE 125-BS

Internal corners

Height in mm	Item no.
100	I-FVAE 100-BS
125	I-FVAE 125-BS



bronze
anodized
brushed



Length: 2.50 m

Height in mm	Item no.
100	FVAE 100-KGS-250
125	FVAE 125-KGS-250

External corners

Height in mm	Item no.
100	E-FVAE 100-KGS
125	E-FVAE 125-KGS

Internal corners

Height in mm	Item no.
100	I-FVAE 100-KGS
125	I-FVAE 125-KGS



copper
high-gloss
anodized
brushed



fuma // ROUND – ROUND EDGE PROFILES
 Aluminum color coated, with corner pieces

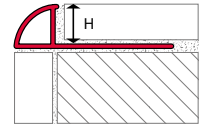

Length: 2.50 m

Height in mm	Item no.
8.0	FVGP 080-BW-250
10.0	FVGP 100-BW-250
12.5	FVGP 125-BW-250

External corners

Height in mm	Item no.
8.0	E-FVGP 080-BW
10.0	E-FVGP 100-BW
12.5	E-FVGP 125-BW

Internal corners

Height in mm	Item no.
8.0	I-FVGP 080-BW
10.0	I-FVGP 100-BW
12.5	I-FVGP 125-BW

brilliant white

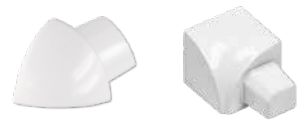

Length: 2.50 m

Height in mm	Item no.
8.0	FVGP 080-SG-250
10.0	FVGP 100-SG-250
12.5	FVGP 125-SG-250

External corners

Height in mm	Item no.
8.0	E-FVGP 080-SG
10.0	E-FVGP 100-SG
12.5	E-FVGP 125-SG

Internal corners

Height in mm	Item no.
8.0	I-FVGP 080-SG
10.0	I-FVGP 100-SG
12.5	I-FVGP 125-SG

silver grey

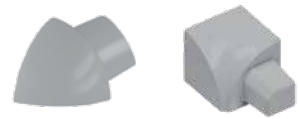

Length: 2.50 m

Height in mm	Item no.
8.0	FVGP 080-BB-250
10.0	FVGP 100-BB-250
12.5	FVGP 125-BB-250

External corners

Height in mm	Item no.
8.0	E-FVGP 080-BB
10.0	E-FVGP 100-BB
12.5	E-FVGP 125-BB

Internal corners

Height in mm	Item no.
8.0	I-FVGP 080-BB
10.0	I-FVGP 100-BB
12.5	I-FVGP 125-BB

bahamabeige

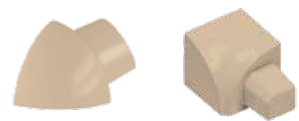

→ More colors on the next page.

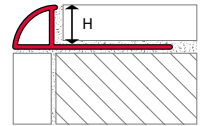

fuma // ROUND - ROUND EDGE PROFILES
 Aluminum color coated, with corner pieces

Length: 2.50 m

Height in mm	Item no.
8.0	FVGP 080-CA-250
10.0	FVGP 100-CA-250
12.5	FVGP 125-CA-250

External corners

Height in mm	Item no.
8.0	E-FVGP 080-CA
10.0	E-FVGP 100-CA
12.5	E-FVGP 125-CA

Internal corners

Height in mm	Item no.
8.0	I-FVGP 080-CA
10.0	I-FVGP 100-CA
12.5	I-FVGP 125-CA

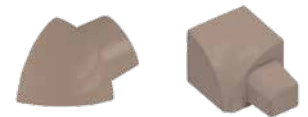

Length: 2.50 m

Height in mm	Item no.
8.0	FVGP 080-AG-250
10.0	FVGP 100-AG-250
12.5	FVGP 125-AG-250

External corners

Height in mm	Item no.
8.0	E-FVGP 080-AG
10.0	E-FVGP 100-AG
12.5	E-FVGP 125-AG

Internal corners

Height in mm	Item no.
8.0	I-FVGP 080-AG
10.0	I-FVGP 100-AG
12.5	I-FVGP 125-AG

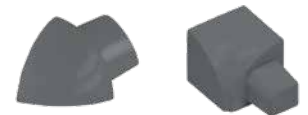

Length: 2.50 m

Height in mm	Item no.
8.0	FVGP 080-MHG-250
10.0	FVGP 100-MHG-250
12.5	FVGP 125-MHG-250

External corners

Height in mm	Item no.
8.0	E-FVGP 080-MHG
10.0	E-FVGP 100-MHG
12.5	E-FVGP 125-MHG

Internal corners

Height in mm	Item no.
8.0	I-FVGP 080-MHG
10.0	I-FVGP 100-MHG
12.5	I-FVGP 125-MHG

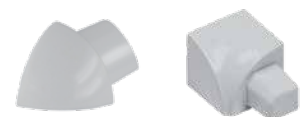

fuma // ROUND – ROUND EDGE PROFILES
 Aluminum texture coated, with corner pieces

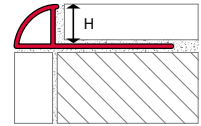

Length: 2.50 m

Height in mm	Item no.
8.0	FVGP 080-GM-250
10.0	FVGP 100-GM-250
12.5	FVGP 125-GM-250

External corners

Height in mm	Item no.
8.0	E-FVGP 080-GM
10.0	E-FVGP 100-GM
12.5	E-FVGP 125-GM

Internal corners

Height in mm	Item no.
8.0	I-FVGP 080-GM
10.0	I-FVGP 100-GM
12.5	I-FVGP 125-GM

grey metallic



Length: 2.50 m

Height in mm	Item no.
8.0	FVGP 080-AT-250
10.0	FVGP 100-AT-250
12.5	FVGP 125-AT-250

External corners

Height in mm	Item no.
8.0	E-FVGP 080-AT
10.0	E-FVGP 100-AT
12.5	E-FVGP 125-AT

Internal corners

Height in mm	Item no.
8.0	I-FVGP 080-AT
10.0	I-FVGP 100-AT
12.5	I-FVGP 125-AT

anthracite



Length: 2.50 m

Height in mm	Item no.
8.0	FVGP 080-TB-250
10.0	FVGP 100-TB-250
12.5	FVGP 125-TB-250

External corners

Height in mm	Item no.
8.0	E-FVGP 080-TB
10.0	E-FVGP 100-TB
12.5	E-FVGP 125-TB

Internal corners

Height in mm	Item no.
8.0	I-FVGP 080-TB
10.0	I-FVGP 100-TB
12.5	I-FVGP 125-TB

terra brown



→ More surfaces on the next page.

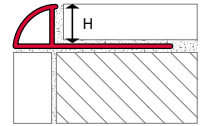

fuma // ROUND - ROUND EDGE PROFILES
 Aluminum texture coated, with corner pieces

Length: 2.50 m

Height in mm	Item no.
8.0	FVGP 080-UB-250
10.0	FVGP 100-UB-250
12.5	FVGP 125-UB-250

External corners

Height in mm	Item no.
8.0	E-FVGP 080-UB
10.0	E-FVGP 100-UB
12.5	E-FVGP 125-UB

Internal corners

Height in mm	Item no.
8.0	I-FVGP 080-UB
10.0	I-FVGP 100-UB
12.5	I-FVGP 125-UB

umbra



Length: 2.50 m

Height in mm	Item no.
8.0	FVGP 080-QZ-250
10.0	FVGP 100-QZ-250
12.5	FVGP 125-QZ-250

External corners

Height in mm	Item no.
8.0	E-FVGP 080-QZ
10.0	E-FVGP 100-QZ
12.5	E-FVGP 125-QZ

Internal corners

Height in mm	Item no.
8.0	I-FVGP 080-QZ
10.0	I-FVGP 100-QZ
12.5	I-FVGP 125-QZ

quarz



Length: 2.50 m

Height in mm	Item no.
8.0	FVGP 080-SD-250
10.0	FVGP 100-SD-250
12.5	FVGP 125-SD-250

External corners

Height in mm	Item no.
8.0	E-FVGP 080-SD
10.0	E-FVGP 100-SD
12.5	E-FVGP 125-SD

Internal corners

Height in mm	Item no.
8.0	I-FVGP 080-SD
10.0	I-FVGP 100-SD
12.5	I-FVGP 125-SD

sand



→ More surfaces on the next page.

fuma // ROUND – ROUND EDGE PROFILES
 Aluminum texture coated, with corner pieces

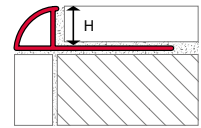

Length: 2.50 m

Height in mm	Item no.
8.0	FVGP 080-DL-250
10.0	FVGP 100-DL-250
12.5	FVGP 125-DL-250

External corners

Height in mm	Item no.
8.0	E-FVGP 080-DL
10.0	E-FVGP 100-DL
12.5	E-FVGP 125-DL

Internal corners

Height in mm	Item no.
8.0	I-FVGP 080-DL
10.0	I-FVGP 100-DL
12.5	I-FVGP 125-DL

dolomite



Length: 2.50 m

Height in mm	Item no.
8.0	FVGP 080-ARC-250
10.0	FVGP 100-ARC-250
12.5	FVGP 125-ARC-250

External corners

Height in mm	Item no.
8.0	E-FVGP 080-ARC
10.0	E-FVGP 100-ARC
12.5	E-FVGP 125-ARC

Internal corners

Height in mm	Item no.
8.0	I-FVGP 080-ARC
10.0	I-FVGP 100-ARC
12.5	I-FVGP 125-ARC

arctic



Length: 2.50 m

Height in mm	Item no.
8.0	FVGP 080-KRD-250
10.0	FVGP 100-KRD-250
12.5	FVGP 125-KRD-250

External corners

Height in mm	Item no.
8.0	E-FVGP 080-KRD
10.0	E-FVGP 100-KRD
12.5	E-FVGP 125-KRD

Internal corners

Height in mm	Item no.
8.0	I-FVGP 080-KRD
10.0	I-FVGP 100-KRD
12.5	I-FVGP 125-KRD

chalk



→ More surfaces on the next page.

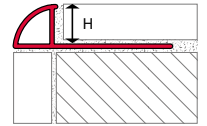

fuma // ROUND - ROUND EDGE PROFILES
Aluminum texture coated, with corner pieces

Length: 2.50 m

Height in mm	Item no.
8.0	FVGP 080-CR-250
10.0	FVGP 100-CR-250
12.5	FVGP 125-CR-250

External corners

Height in mm	Item no.
8.0	E-FVGP 080-CR
10.0	E-FVGP 100-CR
12.5	E-FVGP 125-CR

Internal corners

Height in mm	Item no.
8.0	I-FVGP 080-CR
10.0	I-FVGP 100-CR
12.5	I-FVGP 125-CR

creme



Length: 2.50 m

Height in mm	Item no.
8.0	FVGP 080-MSW-250
10.0	FVGP 100-MSW-250
12.5	FVGP 125-MSW-250

External corners

Height in mm	Item no.
8.0	E-FVGP 080-MSW
10.0	E-FVGP 100-MSW
12.5	E-FVGP 125-MSW

Internal corners

Height in mm	Item no.
8.0	I-FVGP 080-MSW
10.0	I-FVGP 100-MSW
12.5	I-FVGP 125-MSW

black

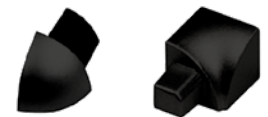

→ More surfaces on the next page.

fuma // ROUND – ROUND EDGE PROFILES
 Aluminum texture coated, with corner pieces

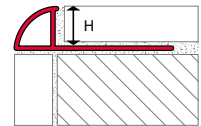

Length: 2.50 m

Height in mm	Item no.
8.0	FVGP 080-SWB-250
10.0	FVGP 100-SWB-250
12.5	FVGP 125-SWB-250

External corners

Height in mm	Item no.
8.0	E-FVGP 080-SWB
10.0	E-FVGP 100-SWB
12.5	E-FVGP 125-SWB

Internal corners

Height in mm	Item no.
8.0	I-FVGP 080-SWB
10.0	I-FVGP 100-SWB
12.5	I-FVGP 125-SWB



Length: 2.50 m

Height in mm	Item no.
8.0	FVGP 080-ATB-250
10.0	FVGP 100-ATB-250
12.5	FVGP 125-ATB-250

External corners

Height in mm	Item no.
8.0	E-FVGP 080-ATB
10.0	E-FVGP 100-ATB
12.5	E-FVGP 125-ATB

Internal corners

Height in mm	Item no.
8.0	I-FVGP 080-ATB
10.0	I-FVGP 100-ATB
12.5	I-FVGP 125-ATB



Length: 2.50 m

Height in mm	Item no.
8.0	FVGP 080-SGB-250
10.0	FVGP 100-SGB-250
12.5	FVGP 125-SGB-250

External corners

Height in mm	Item no.
8.0	E-FVGP 080-SGB
10.0	E-FVGP 100-SGB
12.5	E-FVGP 125-SGB

Internal corners

Height in mm	Item no.
8.0	I-FVGP 080-SGB
10.0	I-FVGP 100-SGB
12.5	I-FVGP 125-SGB



→ More surfaces on the next page.

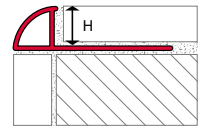

fuma // ROUND - ROUND EDGE PROFILES
 Aluminum texture coated, with corner pieces

Length: 2.50 m

Height in mm	Item no.
8.0	FVGP 080-BGB-250
10.0	FVGP 100-BGB-250
12.5	FVGP 125-BGB-250

External corners

Height in mm	Item no.
8.0	E-FVGP 080-BGB
10.0	E-FVGP 100-BGB
12.5	E-FVGP 125-BGB

Internal corners

Height in mm	Item no.
8.0	I-FVGP 080-BGB
10.0	I-FVGP 100-BGB
12.5	I-FVGP 125-BGB



Length: 2.50 m

Height in mm	Item no.
8.0	FVGP 080-WB-250
10.0	FVGP 100-WB-250
12.5	FVGP 125-WB-250

External corners

Height in mm	Item no.
8.0	E-FVGP 080-WB
10.0	E-FVGP 100-WB
12.5	E-FVGP 125-WB

Internal corners

Height in mm	Item no.
8.0	I-FVGP 080-WB
10.0	I-FVGP 100-WB
12.5	I-FVGP 125-WB



fuma // ROUND – ROUND EDGE PROFILES

PVC, with corner pieces

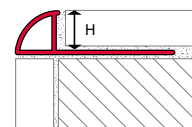

Length: 2.50 m

Height in mm	Item no.
6.0	FVG 060-BW-250
8.0	FVG 080-BW-250
10.0	FVG 100-BW-250
12.5	FVG 125-BW-250

Length: 3.00 m

Height in mm	Item no.
6.0	FVG 060-BW-300
8.0	FVG 080-BW-300
10.0	FVG 100-BW-300
12.5	FVG 125-BW-300

brilliant white



External corners

Height in mm	Item no.
6.0	E-FVG 060-BW
8.0	E-FVG 080-BW
10.0	E-FVG 100-BW
12.5	E-FVG 125-BW



Length: 2.50 m

Height in mm	Item no.
8.0	FVG 080-AW-250
10.0	FVG 100-AW-250
12.5	FVG 125-AW-250

Length: 3.00 m

Height in mm	Item no.
8.0	FVG 080-AW-300
10.0	FVG 100-AW-300
12.5	FVG 125-AW-300

off-white (jasmine)



External corners

Height in mm	Item no.
8.0	E-FVG 080-AW
10.0	E-FVG 100-AW
12.5	E-FVG 125-AW



Length: 2.50 m

Height in mm	Item no.
8.0	FVG 080-SG-250
10.0	FVG 100-SG-250
12.5	FVG 125-SG-250

silver grey



External corners

Height in mm	Item no.
8.0	E-FVG 080-SG
10.0	E-FVG 100-SG
12.5	E-FVG 125-SG



→ More colors on the next page.

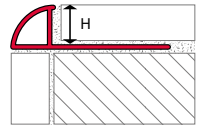

fuma // ROUND - ROUND EDGE PROFILES

PVC, with corner pieces

Length: 2.50 m

Height in mm	Item no.
8.0	FVG 080-CA-250
10.0	FVG 100-CA-250
12.5	FVG 125-CA-250

External corners

Height in mm	Item no.
8.0	E-FVG 080-CA
10.0	E-FVG 100-CA
12.5	E-FVG 125-CA



Length: 2.50 m

Height in mm	Item no.
8.0	FVG 080-PG-250
10.0	FVG 100-PG-250
12.5	FVG 125-PG-250

External corners

Height in mm	Item no.
8.0	E-FVG 080-PG
10.0	E-FVG 100-PG
12.5	E-FVG 125-PG



Length: 2.50 m

Height in mm	Item no.
8.0	FVG 080-SW-250
10.0	FVG 100-SW-250
12.5	FVG 125-SW-250

External corners

Height in mm	Item no.
8.0	E-FVG 080-SW
10.0	E-FVG 100-SW
12.5	E-FVG 125-SW

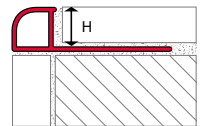

fuma // ROND - ROUND PROFILES

PVC, with corner pieces

Length: 2.50 m

Height in mm	Item no.
8.0	FRO 080-BW-250
10.0	FRO 100-BW-250
12.5	FRO 125-BW-250

Length: 3.00 m

Height in mm	Item no.
8.0	FRO 080-BW-300
10.0	FRO 100-BW-300
12.5	FRO 125-BW-300



External corners

Height in mm	Item no.
8.0	E-FRO 080-BW
10.0	E-FRO 100-BW
12.5	E-FRO 125-BW

Internal corners

Height in mm	Item no.
8.0	I-FRO 080-BW
10.0	I-FRO 100-BW
12.5	I-FRO 125-BW



fuma // DECO – DECORATIVE BORDER PROFILES

Stainless steel 1.4301 / 304, with corner pieces

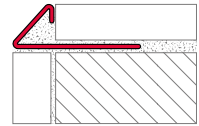

Length: 2.50 m

Height in mm	Item no.
8.0	FDRE 080-250
10.0	FDRE 100-250
12.5	FDRE 125-250

External corners

Height in mm	Item no.
8.0	E-FDRE 080
10.0	E-FDRE 100
12.5	E-FDRE 125

Internal corners

Height in mm	Item no.
8.0	I-FDRE 080
10.0	I-FDRE 100
12.5	I-FDRE 125

glossy

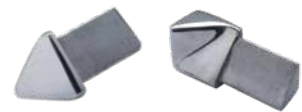

Length: 2.50 m

Height in mm	Item no.
8.0	FDRES 080-250
10.0	FDRES 100-250
12.5	FDRES 125-250

External corners

Height in mm	Item no.
8.0	E-FDRES 080
10.0	E-FDRES 100
12.5	E-FDRES 125

Internal corners

Height in mm	Item no.
8.0	I-FDRES 080
10.0	I-FDRES 100
12.5	I-FDRES 125

brushed

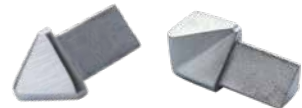

fuma // MITER – TRIANGULAR EDGE PROFILES
 Stainless steel 1.4301/304, inclined version 135°

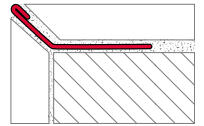

Length: 2.50 m

Height in mm	Item no.
8.0	FSKE 080-250
10.0	FSKE 100-250
12.5	FSKE 125-250

glossy



fuma // MITER – TRIANGULAR EDGE PROFILES
 Aluminum, inclined version 135°

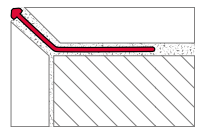

Length: 2.50 m

Height in mm	Item no.
8.0	FSKAE 080-250
10.0	FSKAE 100-250
12.5	FSKAE 125-250

silver
anodized



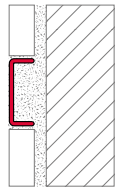

fuma // LISTELL - SEPARATING DECORATIVE PROFILES

Stainless steel 1.4301 / 304, installation depth: 7 mm, material thickness: 1 mm

Length: 2.50 m

Width in mm	Item no.
20.0	FDEP 200-250
25.0	FDEP 250-250

glossy



Length: 2.50 m

Width in mm	Item no.
20.0	FDES 200-250
25.0	FDES 250-250

brushed



fuma // LISTELL - SEPARATING DECORATIVE PROFILES

Aluminum, visible surface: 25 mm, installation depth: 8 mm

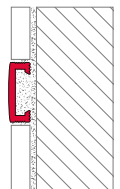

Length: 2.50 m

Width in mm	Item no.
25.0	FDAE 250

silver anodized



Length: 2.50 m

Width in mm	Item no.
25.0	FDSP 250

silver high-gloss anodized



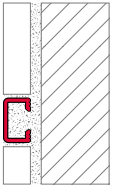

fuma // LISTELL – SEPARATING DECORATIVE PROFILES

Aluminum, visible surfaces / widths: 10 / 15 mm, installation depth: 8 mm

Length: 2.50 m

Width in mm	Item no.
100	FDAE 100-250
150	FDAE 150-250

silver
anodized



Length: 2.50 m

Width in mm	Item no.
100	FDHS 100-250
150	FDHS 150-250

silver
high-gloss
anodized



Length: 2.50 m

Width in mm	Item no.
100	FDGS 100-250
150	FDGS 150-250

silver
high-gloss
anodized
brushed



fuma // T - SEPARATION AND COVER PROFILES
Stainless steel 1.4301 / 304

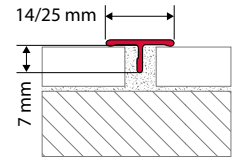

Length: 2.50 m

Visible width in mm	Item no.
14.0	FTEP 147-250
25.0	FTEP 259-250

polished



Length: 2.50 m

Visible width in mm	Item no.
14.0	FTES 147-250
25.0	FTES 259-250

brushed



fuma // T - SEPARATION AND COVER PROFILES
Aluminum

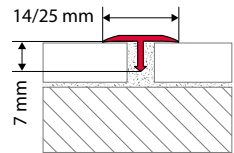

Length: 2.50 m

Visible width in mm	Item no.
14.0	FTAN 147-250
25.0	FTAN 259-250

natural



Length: 2.50 m

Visible width in mm	Item no.
14.0	FTAS 147-250
25.0	FTAS 259-250

silver anodized



Length: 2.50 m

Visible width in mm	Item no.
14.0	FTAE 147-M-250
25.0	FTAE 259-M-250

brass anodized



Length: 2.50 m

Visible width in mm	Item no.
14.0	FTAT 147-250
25.0	FTAT 259-250

titanium anodized



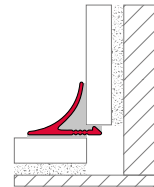

fuma // COVE - COVE PROFILES

Aluminum, retrofitting possible

Length: 2.50 m

Height in mm	Item no.
8.0	FRAE 080-250
12.0	FRAE 120-250

Length: 2.50 m

Height in mm	Item no.
8.0	FRAH 080-250
12.0	FRAH 120-250

Length: 2.50 m

Height in mm	Item no.
8.0	FRAP 080-250
12.0	FRAP 120-250

silver anodized



silver high-gloss anodized



color coated brilliant white



// ACCESSORIES KIT

2 internal, 2 external- and 2 endcaps made of PVC

Kit - silver anodized

Height in mm	Item no.
8.0	FRAE 080/BL
12.0	FRAE 120/BL

Kit - silver high-gloss anodized

Height in mm	Item no.
8.0	FRAH 080/BL
12.0	FRAH 120/BL

Kit - color coated brilliant white

Height in mm	Item no.
8.0	FRAP 080/BL
12.0	FRAP 120/BL

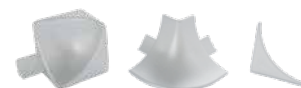

fuma // COVE - COVE PROFILES

Aluminum, visible width: 40 mm, retrofitting possible

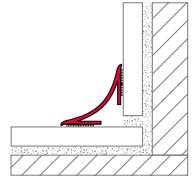

Length: 2.50 m

Height in mm	Item no.
28.0	FRAE 400-250

silver anodized



// ACCESSORIES

External corner

Height in mm	Item no.
28.0	FRAE-A 400



End cap

Height in mm	Item no.
28.0	FRAE-EK 400



Internal corner - two-sided connection

Height in mm	Item no.
28.0	FRAE-I 400



Internal corner - three-sided connection

Height in mm	Item no.
28.0	FRAE-I 400 3D



fuma // COVE - COVE PROFILES

Aluminum, one-sided connection

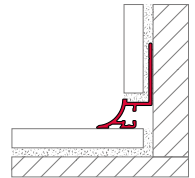

Length: 2.50 m

Height in mm	Item no.
10.0	FCAE 100-250
12.5	FCAE 125-250

silver anodized



// ACCESSORIES - SUITABLE FOR ALL HEIGHTS

External corner

Item no.
E-FCAE



Internal corner

Item no.
I-FCAE



End cap left

Item no.
EK-L-FCAE



End cap right

Item no.
EK-R-FCAE



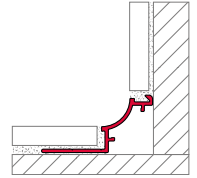

fuma // COVE - COVE PROFILES
Aluminum, two-sided connection

Length: 2.50 m

Height in mm	Item no.
100	FRAE 100-250
12.5	FRAE 125-250

Length: 2.50 m

Height in mm	Item no.
100	FRAE 100-SGS-250
12.5	FRAE 125-SGS-250

Length: 2.50 m

Height in mm	Item no.
100	FRAE 100-T-250
12.5	FRAE 125-T-250

Length: 2.50 m

Height in mm	Item no.
100	FRAE 100-TGS-250
12.5	FRAE 125-TGS-250

silver anodized



silver high-gloss anodized brushed



titanium anodized



titanium high-gloss anodized brushed

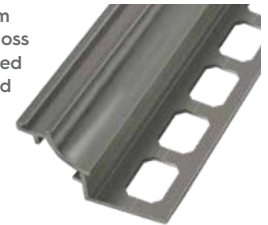

// ACCESSORIES - SUITABLE FOR ALL HEIGHTS

External corner

Surface	Item no.
silver anodized	E-FRAE
silver high-gloss anodized brushed	E-FRAE-SGS
titanium anodized	E-FRAE-T
titanium high-gloss anodized brushed	E-FRAE-TGS

Internal corner

Surface	Item no.
silver anodized	I-FRAE
silver high-gloss anodized brushed	I-FRAE-SGS
titanium anodized	I-FRAE-T
titanium high-gloss anodized brushed	I-FRAE-TGS



External corner

Internal corner

End cap left + right

Surface	Item no.
silver anodized	EK-FRAE
silver high-gloss anodized brushed	EK-FRAE-SGS
titanium anodized	EK-FRAE-T
titanium high-gloss anodized brushed	EK-FRAE-TGS

Connector

Surface	Item no.
natur	V-FRAE



End cap

Connector

Connector suitable for all colours.

“Our stair-nosing profiles are useful for several reasons: they provide a non-slip surface, reduce the risk of accidents and protect the tile edges from damage.”

IMER ASANI

part of the fuma-Bautec team
since 2018

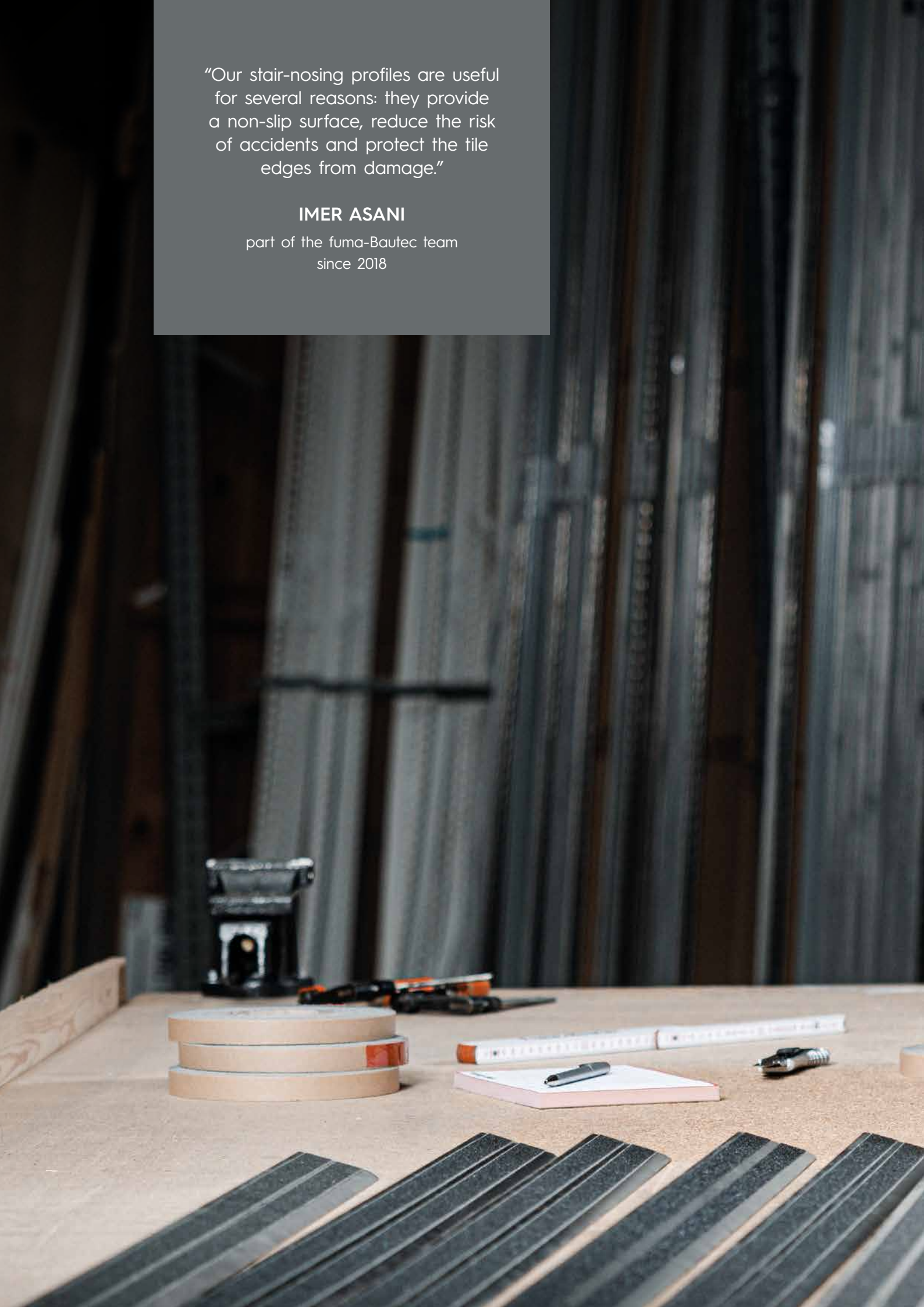



STAIR-NOSING PROFILES /
TRANSITION PROFILES

PAGE 56 - 65

fuma // STEP - STAIR-NOSING PROFILES
 Aluminum, with Florentine design

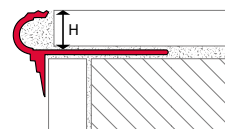

Length: 2.50 m

Height in mm	Item no.
7.0	FTA 070-250
9.0	FTA 090-250
11.0	FTA 110-250

Length: 3.00 m

Height in mm	Item no.
-	-
9.0	FTA 090-300
11.0	FTA 110-300

natural



Length: 2.50 m

Height in mm	Item no.
9.0	FTAS 090-250
11.0	FTAS 110-250

Length: 3.00 m

Height in mm	Item no.
9.0	FTAS 090-300
11.0	FTAS 110-300

silver anodized

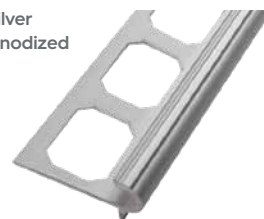

// ACCESSORIES MADE OF METAL DIE-CAST

External corner

Height in mm	Item no.
7.0	A-FTAS 070
9.0	A-FTAS 090
11.0	A-FTAS 110

Internal corner

Height in mm	Item no.
7.0	I-FTAS 070
9.0	I-FTAS 090
11.0	I-FTAS 110



End cap on the left

Height in mm	Item no.
7.0	K-FTAS 070L
9.0	K-FTAS 090L
11.0	K-FTAS 110L

End cap on the right

Height in mm	Item no.
7.0	K-FTAS 070R
9.0	K-FTAS 090R
11.0	K-FTAS 110R



End caps and corner pieces are suitable for both surfaces.

fuma // STEP – STAIR-NOSING PROFILES
 Stainless steel 1.4301 / 304, surface: grooved

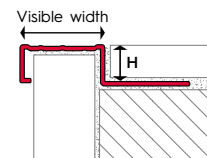

Length: 2.50 m

Height in mm	Visible width in mm	Item no.
9.0	30	FTRE 090-250
11.0	30	FTRE 110-250

Length: 3.00 m

Height in mm	Visible width in mm	Item no.
9.0	30	FTRE 090-300
11.0	30	FTRE 110-300



End caps

Item no.
FTRE 90/110

Suitable for both heights.

fuma // STEP – STAIR-NOSING PROFILES
 Aluminum, surface: grooved

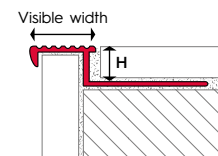

Length: 2.50 m

Height in mm	Visible width in mm	Item no.
9.0	20	FTRN 090-250
11.0	20	FTRN 110-250
9.0	30	FTRN-L 090-250
11.0	30	FTRN-L 110-250

Length: 3.00 m

Height in mm	Visible width in mm	Item no.
9.0	20	FTRN 090-300
11.0	20	FTRN 110-300
9.0	30	FTRN-L 090-300
11.0	30	FTRN-L 110-300



Length: 2.50 m

Height in mm	Visible width in mm	Item no.
9.0	20	FTRS 090-250
11.0	20	FTRS 110-250
9.0	30	FTRS-L 090-250
11.0	30	FTRS-L 110-250

Length: 3.00 m

Height in mm	Visible width in mm	Item no.
9.0	20	FTRS 090-300
11.0	20	FTRS 110-300
9.0	30	FTRS-L 090-300
11.0	30	FTRS-L 110-300

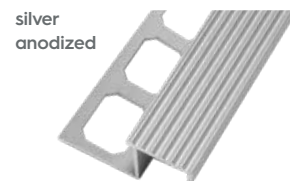

fuma // STEP - STAIR-NOSING PROFILES

Aluminum, for stone carpets, 5 mm wide, bevelled top edge

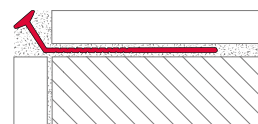

Length: 2.50 m

Height in mm	Support leg in mm	Item no.
8	45	FTAR 0805-250

natural



fuma // STEP - STAIR-NOSING PROFILES

Stainless steel 1.4301 / 304, with anti-slip safety infill R9/single channel, width: 54 mm

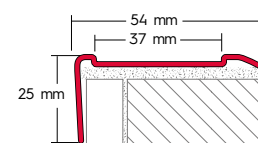

Base profile without infill - length: 2.50 m

Height in mm	Item no.
25	FTE 5425

glossy

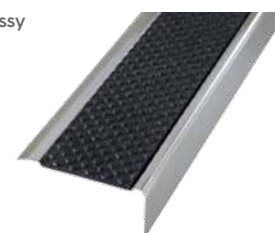

The anti-slip infill is supplied loose. After assembly (screwing) of the profiles, the infill is glued in place.

Infill black

Width in mm	Item no.
37	E 8637-SW

infill:
black



fuma // STEP - STAIR-NOSING PROFILES

Aluminum, with anti-slip safety infill R9, visible width: 17 mm

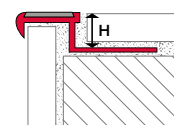

Length: 2.50 m

Height in mm	Item no.
9	FTAL-S 091-250
11	FTAL-S 111-250

silver anodized,
infill:
black



Infill width: 13 mm.

fuma // STEP – STAIR-NOSING PROFILES

Aluminum, with anti-slip safety infill R9/**single channel**, width: **58 mm**

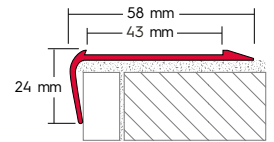

Base profile without infill - length: 2.50 m

Height in mm	Item no.
24	FTAE 5824-250

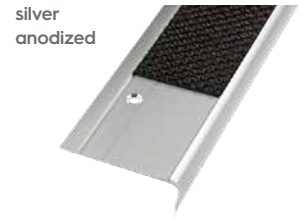

The anti-slip infill is supplied loose. The stair profiles are pre-drilled for fastening. After assembly (screwing) of the profiles, the infill is glued in place.

Infill black

Width in mm	Item no.
43	E 5843-SW

infill:
black



fuma // STEP – STAIR-NOSING PROFILES

Aluminum, with anti-slip safety infill R9/**double channel**, width: **86 mm**

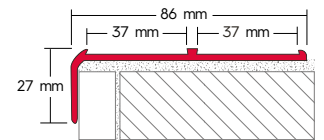

Base profile without infill - length: 2.50 m

Height in mm	Item no.
27	FTAZ 8627-250



The anti-slip insert is supplied loose. The stair profiles are pre-drilled for fastening. After assembly (screwing) of the profiles, the insert is glued in place.

Infill black

Width in mm	Item no.
37	E 8637-SW

infill:
black



fuma // STEP - STAIR-NOSING PROFILES

Stainless steel 1.4301 / 304, with Safety-Walk infill R13 / single channel, width: 40 mm



Length: 150 cm		Length: 2.50 m		Length: 3.00 m	
Height in mm	Item no.	Height in mm	Item no.	Height in mm	Item no.
20	FSAE 4020-SW-150	20	FSAE 4020-SW-250	20	FSAE 4020-SW-300

Length: 150 cm		Length: 2.50 m		Length: 3.00 m	
Height in mm	Item no.	Height in mm	Item no.	Height in mm	Item no.
20	FSAE 4020-TR-150	20	FSAE 4020-TR-250	20	FSAE 4020-TR-300

brushed,
infill:
black



brushed,
infill:
transparent

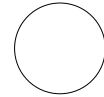

Material thickness: 1.5 mm (2.0 and 3.0 mm available on request).
Attention: Not for outdoor use, not suitable for heavily frequented public staircases (max. 1,000,000 walks/3 years).
Infill width: 19 mm.

fuma // STEP - STAIR-NOSING PROFILES

Stainless steel 1.4301 / 304, with Safety-Walk infill R13 / double channel, width: 60 mm



Length: 150 cm		Length: 2.50 m		Length: 3.00 m	
Height in mm	Item no.	Height in mm	Item no.	Height in mm	Item no.
20	FSAD 6020-SW-150	20	FSAD 6020-SW-250	20	FSAD 6020-SW-300

Length: 150 cm		Length: 2.50 m		Length: 3.00 m	
Height in mm	Item no.	Height in mm	Item no.	Height in mm	Item no.
20	FSAD 6020-TR-150	20	FSAD 6020-TR-250	20	FSAD 6020-TR-300

brushed,
infill:
black

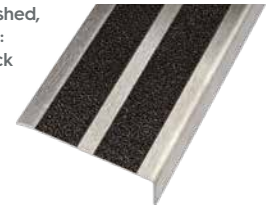

brushed,
infill:
transparent

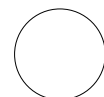

Material thickness: 1.5 mm (2.0 and 3.0 mm available on request).
Attention: Not for outdoor use, not suitable for heavily frequented public staircases (max. 1,000,000 walks/3 years).
Infill width: each 19 mm.

fuma // STEP – STAIR-NOSING PROFILES

Aluminum, self-adhesive, width: 25 mm

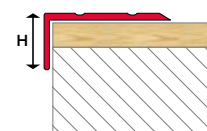

Length: 1.00 m

Height in mm	Item no.
10	FT-SI 1010-SK
20	FT-SI 1020-SK

Length: 2.70 m

Height in mm	Item no.
10	FT-SI 2710-SK
20	FT-SI 2720-SK

silver anodized



1.00 m-lengths DIY-packed.

fuma // STEP – STAIR-NOSING PROFILES

Aluminum, drilled, width: 25 mm

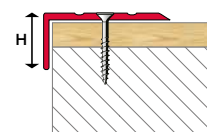

Length: 1.00 m

Height in mm	Item no.
10	FT-SI 1010-G
20	FT-SI 1020-G

Length: 2.70 m

Height in mm	Item no.
10	FT-SI 2710-G
20	FT-SI 2720-G

silver anodized



1.00 m-lengths DIY-packed.

fuma // STEP – STAIR-NOSING PROFILES

Aluminum, surface: grooved, undrilled, width: 40 mm



Length: 1.00 m

Height in mm	Item no.
20	FT-SI 1040-U

Length: 2.70 m

Height in mm	Item no.
20	FT-SI 2740-U

silver anodized



1.00 m-lengths DIY-packed.

fuma // STEP – STAIR-NOSING PROFILES

Aluminum, surface: grooved, drilled, width: 40 mm

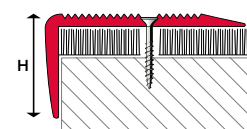

Length: 1.00 m

Height in mm	Item no.
20	FT-SI 1040-G

Length: 2.70 m

Height in mm	Item no.
20	FT-SI 2740-G

silver anodized



1.00 m-lengths DIY-packed incl. screws and dowels.

2.70 m-lengths without fixing material.

fuma // LEVEL – TRANSITION AND COMPENSATION PROFILES
Stainless steel 1.4301 / 304

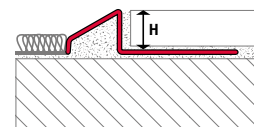

Length: 2.50 m

Height in mm	Visible width in mm	Item no.
8.0	13.0	FUEG 080-250
10.0	18.0	FUEG 100-250
12.5	23.0	FUEG 125-250

Length: 2.50 m

Height in mm	Visible width in mm	Item no.
8.0	13.0	FUES 080-250
10.0	18.0	FUES 100-250
12.5	23.0	FUES 125-250



fuma // LEVEL – TRANSITION AND COMPENSATION PROFILES
Aluminum

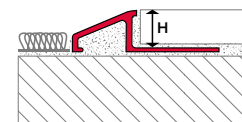

Length: 2.50 m

Height in mm	Visible width in mm	Item no.
8.0	15.2	FTRAE 080-250
10.0	18.0	FTRAE 100-250
12.5	22.6	FTRAE 125-250

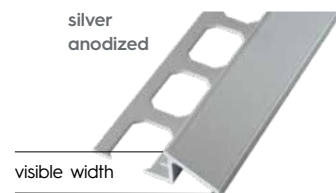

fuma // LEVEL – TRANSITION AND COMPENSATION PROFILES
Aluminum, ramp profiles



Length: 2.50 m

Height in mm	Visible width in mm	Item no.
10.0	65.0	FRAM 100/65-250
11.0	65.0	FRAM 110/65-250
12.5	65.0	FRAM 125/65-250
15.0	89.0	FRAM 150/89-250



Length: 2.50 m

Height in mm	Visible width in mm	Item no.
10.0	65.0	FREM 100/65-250
11.0	65.0	FREM 110/65-250
12.5	65.0	FREM 125/65-250
15.0	89.0	FREM 150/89-250

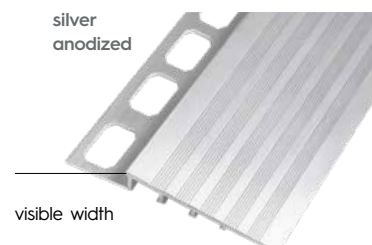

fuma // BRIDGE - TRANSITION PROFILES

Aluminum, self-adhesive, visible width: 38 mm, extra flat

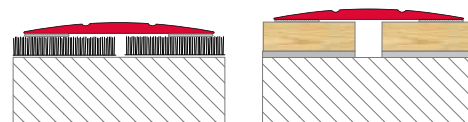

Length: 0.90 m

Item no.
TF-SI 0938-SK

Length: 2.70 m

Item no.
TF-SI 2738-SK



fuma // BRIDGE - TRANSITION PROFILES

Aluminum, drilled, visible width: 38 mm, extra flat



Length: 0.90 m

Item no.
TF-SI 0938

Length: 2.70 m

Item no.
TF-SI 2738



0.90 m-lengths DIY-packed incl. screws and dowels.

2.70 m-lengths without fixing material.

fuma // BRIDGE - TRANSITION AND COMPENSATION PROFILES

Aluminum, self-adhesive

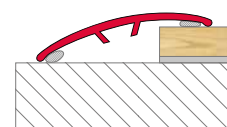

Length: 0.90 m

Height in mm	Visible width in mm	Item no.
0 - 9	30	HM-SI 0930-SK
0 - 14	40	HM-SI 0940-SK

Length: 2.70 m

Height in mm	Visible width in mm	Item no.
0 - 9	30	HM-SI 2730-SK
0 - 14	40	HM-SI 2740-SK



Length: 0.90 m

Height in mm	Visible width in mm	Item no.
0 - 9	30	HM-TI 0930-SK
0 - 14	40	HM-TI 0940-SK

Length: 2.70 m

Height in mm	Visible width in mm	Item no.
0 - 9	30	HM-TI 2730-SK
0 - 14	40	HM-TI 2740-SK



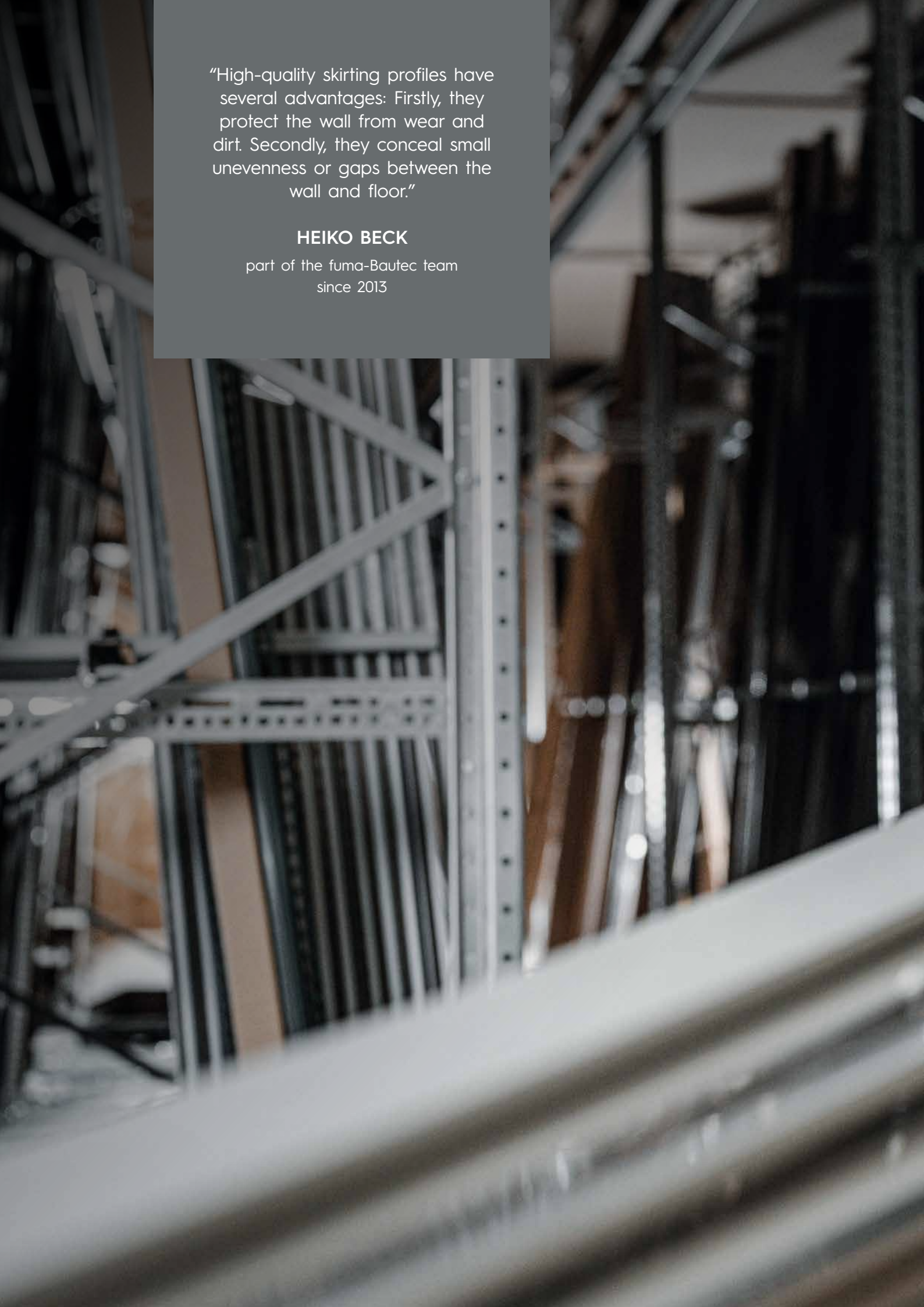

“High-quality skirting profiles have several advantages: Firstly, they protect the wall from wear and dirt. Secondly, they conceal small unevenness or gaps between the wall and floor.”

HEIKO BECK

part of the fuma-Bautec team
since 2013



fuma // BASE – SKIRTING PROFILES

Aluminum, with accessories made of metal die-cast

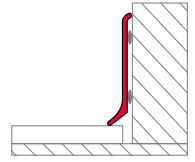

Length: 2.50 m

Height in mm	Item no.
60	SLS 6010-250
80	SLS 8010-250
100	SLS 10010-250

silver anodized



Length: 2.50 m

Height in mm	Item no.
60	SLF 6040-250
80	SLF 8040-250
-	-

silver anodized brushed



Length: 2.50 m

Height in mm	Item no.
60	SLT 6030-250
80	SLT 8030-250
-	-

titanium anodized



fuma // BASE – ACCESSORIES SKIRTING PROFILES

// CONNECTORS

silver		silver brushed		titanium	
Height in mm	Item no.	Height in mm	Item no.	Height in mm	Item no.
60	SLS-V 6010	60	SLF-V 6040	60	SLT-V 6030
80	SLS-V 8010	80	SLF-V 8040	80	SLT-V 8030
100	SLS-V 10010	-	-	-	-

Connectors



// EXTERNAL CORNERS

silver		silver brushed		titanium	
Height in mm	Item no.	Height in mm	Item no.	Height in mm	Item no.
60	SLS-A 6010	60	SLF-A 6040	60	SLT-A 6030
80	SLS-A 8010	80	SLF-A 8040	80	SLT-A 8030
100	SLS-A 10010	-	-	-	-

External corners



// INTERNAL CORNERS

silver		silver brushed		titanium	
Height in mm	Item no.	Height in mm	Item no.	Height in mm	Item no.
60	SLS-I 6010	60	SLF-I 6040	60	SLT-I 6030
80	SLS-I 8010	80	SLF-I 8040	80	SLT-I 8030
100	SLS-I 10010	-	-	-	-

Internal corners



// END CAPS LEFT

silver		silver brushed		titanium	
Height in mm	Item no.	Height in mm	Item no.	Height in mm	Item no.
60	SLS-L 6010	60	SLF-L 6040	60	SLT-L 6030
80	SLS-L 8010	80	SLF-L 8040	80	SLT-L 8030
100	SLS-L 10010	-	-	-	-

End caps left



// END CAPS RIGHT

silver		silver brushed		titanium	
Height in mm	Item no.	Height in mm	Item no.	Height in mm	Item no.
60	SLS-R 6010	60	SLF-R 6040	60	SLT-R 6030
80	SLS-R 8010	80	SLF-R 8040	80	SLT-R 8030
100	SLS-R 10010	-	-	-	-

End caps right





CORNER PROTECTION PROFILES

PAGE 70 - 73

A close-up photograph of a corner protection profile installed on a wall. The profile is a long, thin, metallic strip with a brushed finish, mounted at the corner of a wall. The background is a dark, textured wall. The profile is shown in a perspective view, highlighting its L-shaped design.

“Corner protection profiles are used to protect the corners of walls from damage. They provide long-lasting and safe protection, especially in areas with high traffic, such as warehouses or production halls.”

IMER ASANI

part of the fuma-Bautec team
since 2018

fuma // PROTECT – CORNER PROTECTION PROFILES

Stainless steel 1.4301 / 304, 1-fold edged

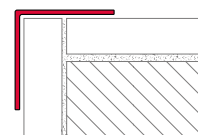

Length: 2.50 m

Angle measure in mm	Material thickness in mm	Item no.
25 x 25	1.0	NG 2510-250
30 x 30	1.0	NG 3010-250
40 x 40	1.0	NG 4010-250
50 x 50	1.0	NG 5010-250
60 x 60	1.0	NG 6010-250

Length: 2.50 m

Angle measure in mm	Material thickness in mm	Item no.
25 x 25	1.5	NG 2515-250
30 x 30	1.5	NG 3015-250
40 x 40	1.5	NG 4015-250
50 x 50	1.5	NG 5015-250
60 x 60	1.5	NG 6015-250

matt /
smooth 3c

Length: 2.50 m

Angle measure in mm	Material thickness in mm	Item no.
25 x 25	1.0	NS 2510-250
30 x 30	1.0	NS 3010-250
40 x 40	1.0	NS 4010-250
50 x 50	1.0	NS 5010-250
60 x 60	1.0	NS 6010-250

Length: 2.50 m

Angle measure in mm	Material thickness in mm	Item no.
25 x 25	1.5	NS 2515-250
30 x 30	1.5	NS 3015-250
40 x 40	1.5	NS 4015-250
50 x 50	1.5	NS 5015-250
60 x 60	1.5	NS 6015-250

brushed



Other lengths and special angle dimensions available at short notice on request.

fuma // PROTECT – CORNER PROTECTION PROFILES

Stainless steel 1.4301 / 304, 3-fold edged

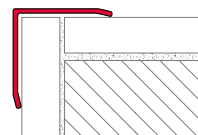

Length: 2.50 m

Angle measure in mm	Material thickness in mm	Item no.
25 x 25	1.0	EG 2510-250
30 x 30	1.0	EG 3010-250
40 x 40	1.0	EG 4010-250
50 x 50	1.0	EG 5010-250
60 x 60	1.0	EG 6010-250

Length: 2.50 m

Angle measure in mm	Material thickness in mm	Item no.
25 x 25	1.5	EG 2515-250
30 x 30	1.5	EG 3015-250
40 x 40	1.5	EG 4015-250
50 x 50	1.5	EG 5015-250
60 x 60	1.5	EG 6015-250

matt /
smooth 3c

Length: 2.50 m

Angle measure in mm	Material thickness in mm	Item no.
25 x 25	1.0	ES 2510-250
30 x 30	1.0	ES 3010-250
40 x 40	1.0	ES 4010-250
50 x 50	1.0	ES 5010-250
60 x 60	1.0	ES 6010-250

Length: 2.50 m

Angle measure in mm	Material thickness in mm	Item no.
25 x 25	1.5	ES 2515-250
30 x 30	1.5	ES 3015-250
40 x 40	1.5	ES 4015-250
50 x 50	1.5	ES 5015-250
60 x 60	1.5	ES 6015-250

brushed



Other lengths and special angle dimensions available at short notice on request.

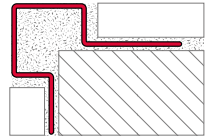

fuma // PROTECT – CORNER PROTECTION PROFILES

Stainless steel 1.4301/304, angle measure: 40 x 40 mm, 90° with continuous anchor rail

Length: 3.00 m

Height in mm	Material thickness in mm	Item no.
7.0	1.0	ASF 407-300
9.0	1.0	ASF 409-300
11.0	1.0	ASF 411-300

brushed



fuma // PROTECT – CORNER PROTECTION PROFILES

Aluminum

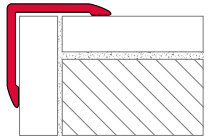

Length: 2.50 m

Angle measure in mm	Material thickness in mm	Item no.
25 x 25	2.0	FES 2520-250

silver anodized



Length: 2.50 m

Angle measure in mm	Material thickness in mm	Item no.
25 x 25	2.0	FEG 2520-250

gold anodized



Length: 2.50 m

Angle measure in mm	Material thickness in mm	Item no.
25 x 25	2.0	FEP 2520-BW-250

color coated brilliant white

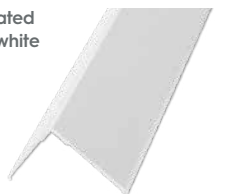



BALCONY PROFILES /
GRAVEL BED BEARING / TILE SPACERS

PAGE 74 - 81

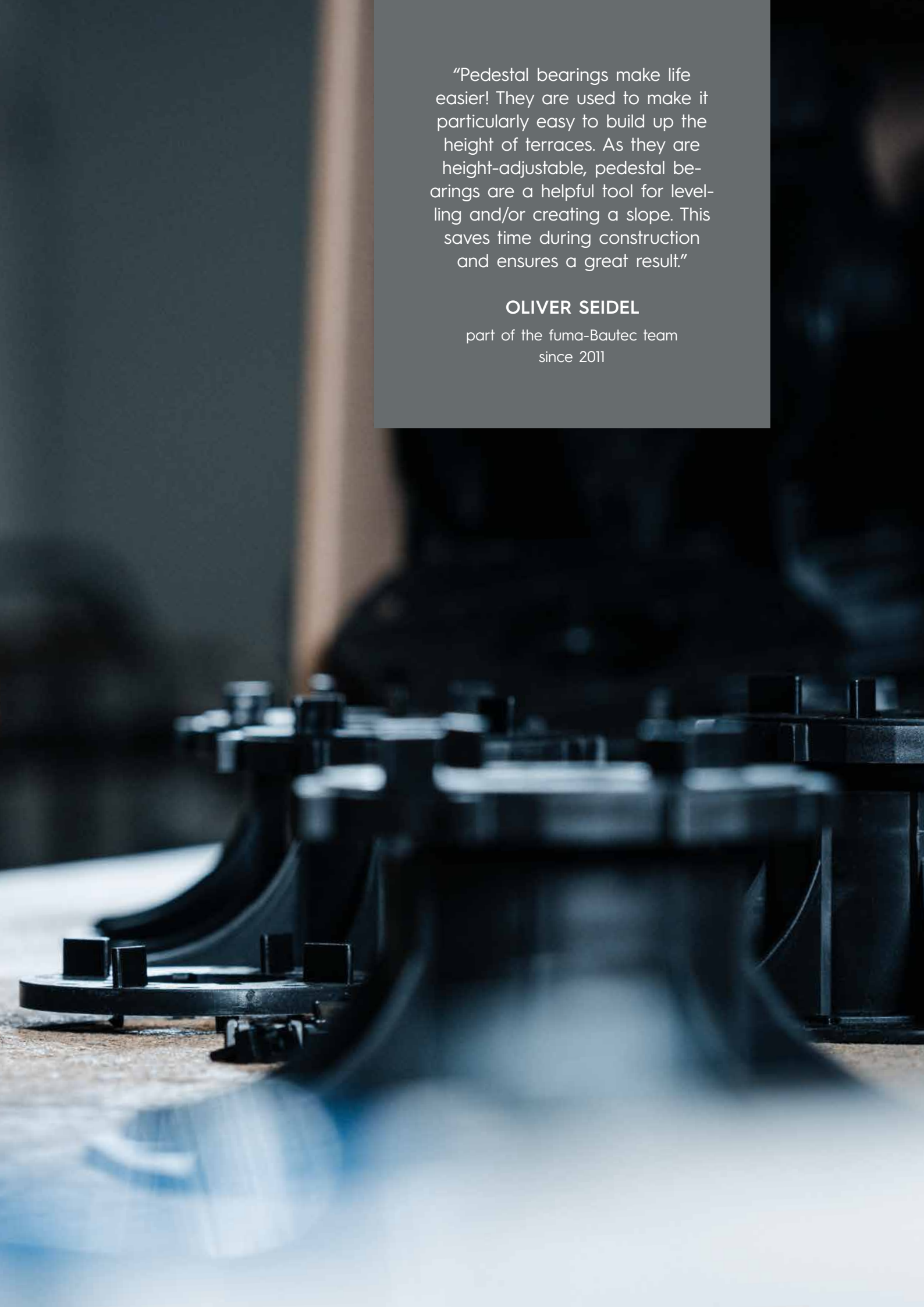

“Pedestal bearings make life easier! They are used to make it particularly easy to build up the height of terraces. As they are height-adjustable, pedestal bearings are a helpful tool for leveling and/or creating a slope. This saves time during construction and ensures a great result.”

OLIVER SEIDEL

part of the fuma-Bautec team
since 2011

fuma // OUTDOOR – BALCONY PROFILES

Stainless steel 1.4301 / 304, without drip edge, support leg: 80 mm, with accessories

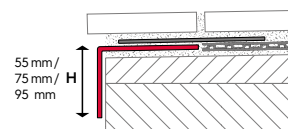

Length: 3.00 m

Height in mm	Item no.
55	FBES 055-300
75	FBES 075-300
95	FBES 095-300

External corners

Height in mm	Item no.
55	FBEES 055
75	FBEES 075
95	FBEES 095

Connector

Height in mm	Item no.
55	FBEVS 055
75	FBEVS 075
95	FBEVS 095

brushed

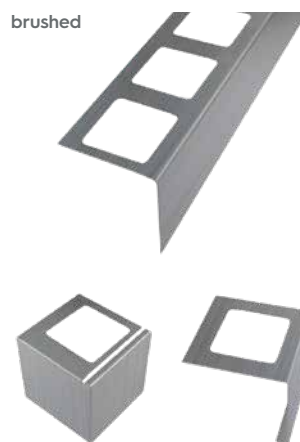

fuma // OUTDOOR – BALCONY PROFILES

Aluminum color coated, without drip edge, support leg: 80 mm, with accessories

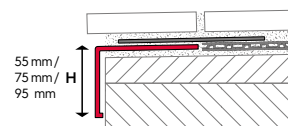

Length: 3.00 m

Height in mm	Item no.
55	FBA 055-HG-300
75	FBA 075-HG-300
95	FBA 095-HG-300

External corners

Height in mm	Item no.
55	FBAE 055-HG
75	FBAE 075-HG
95	FBAE 095-HG

Connector

Height in mm	Item no.
55	FBAV 055-HG
75	FBAV 075-HG
95	FBAV 095-HG

RAL 7035 light grey

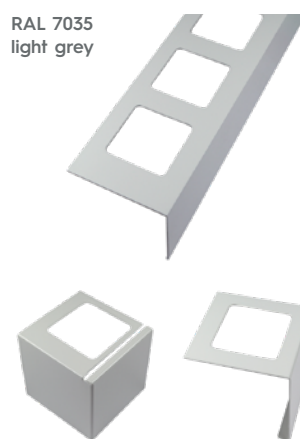

Length: 3.00 m

Height in mm	Item no.
55	FBA 055-GM-300
75	FBA 075-GM-300
95	FBA 095-GM-300

External corners

Height in mm	Item no.
55	FBAE 055-GM
75	FBAE 075-GM
95	FBAE 095-GM

Connector

Height in mm	Item no.
55	FBAV 055-GG
75	FBAV 075-GG
95	FBAV 095-GG

RAL 9007 grey metallic

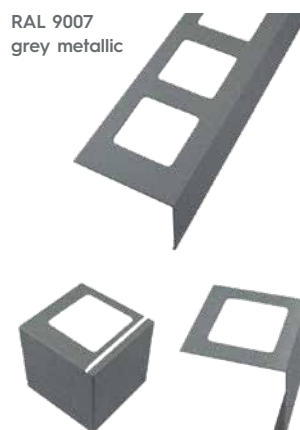

fuma // OUTDOOR – BALCONY PROFILES

Aluminum color coated, without drip edge, support leg: **80 mm**, with accessories

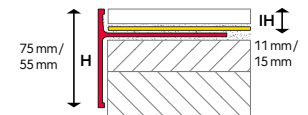

Length: 3.00 m - with longitudinal hole

External height in mm	Internal height in mm	Item no.
75	11	FBT 110-HG-300
55	15	FBT 150-HG-300

RAL 7035
light grey

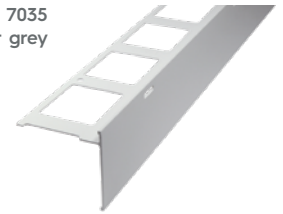

External corners

External height in mm	Internal height in mm	Item no.
75	11 + 24	FBTA 110-HG
55	15	FBTA 150-HG

Connector

External height in mm	Item no.
75	FBTV 110-HG
55	FBTV 150-HG



Length: 3.00 m - with longitudinal hole

External height in mm	Internal height in mm	Item no.
75	11	FBT 110-GM-300
55	15	FBT 150-GM-300

RAL 9007
grey metallic



External corners

External height in mm	Internal height in mm	Item no.
75	11 + 24	FBTA 110-GM
55	15	FBTA 150-GM

Connector

External height in mm	Item no.
75	FBTV 110-GM
55	FBTV 150-GM

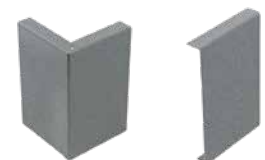

fuma // OUTDOOR – BALCONY PROFILES

Aluminum color coated, with drip edge, support leg: 80 mm, with accessories

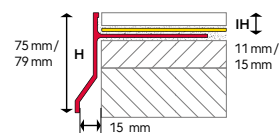

Length: 3.00 m - with longitudinal hole

External height in mm	Internal height in mm	Item no.
75	11	FBS 110-HG-300
79	15	FBS 150-HG-300

RAL 7035 light grey



External corners

External height in mm	Internal height in mm	Item no.
75	11	FBSA 110-HG
79	15	FBSA 150-HG

Connector

External height in mm	Item no.
75	FBSV 110-HG
79	FBSV 150-HG

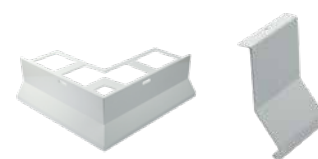

Length: 3.00 m - with longitudinal hole

External height in mm	Internal height in mm	Item no.
75	11	FBS 110-GM-300
79	15	FBS 150-GM-300

RAL 9007 grey metallic



External corners

External height in mm	Internal height in mm	Item no.
75	11	FBSA 110-GM
79	15	FBSA 150-GM

Connector

External height in mm	Item no.
75	FBSV 110-GM
79	FBSV 150-GM

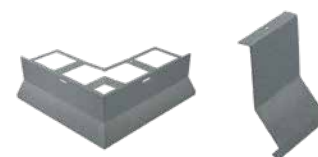

These profiles require connectors for the corner combination (profile and corner).

fuma // OUTDOOR – BALCONY PROFILES

Aluminum, with drip edge, support leg: 60 mm, with accessories

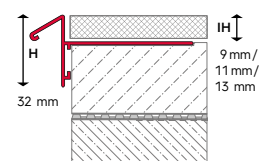

Length: 3.00 m

External height in mm	Internal height in mm	Item no.
32	9	FBSAE 090-300
32	11	FBSAE 110-300
32	13	FBSAE 130-300

silver anodized

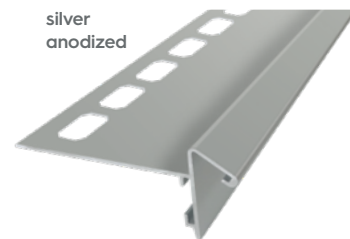

External corners

External height in mm	Item no.
32	FBSAE-A

Internal corners pieces

External height in mm	Item no.
32	FBSAE-I

Connector

Height in mm	Item no.
32	FBSAE-V



These profiles require connectors for the corner combination (profile and corner).

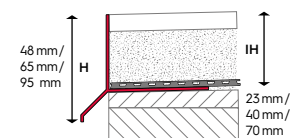

fuma // OUTDOOR – GRAVEL BED ANGLE PROFILES

aluminum color coated, with drip edge, support leg: 100 mm, with accessories

Length: 3.00 m - with longitudinal hole

External height in mm	Internal height in mm	Item no.
48	23	FKP 048-HG-300
65	40	FKP 065-HG-300
95	70	FKP 095-HG-300



RAL 7035
light grey

External corners

External height in mm	Internal height in mm	Item no.
48	23	FKPE 048-HG
65	40	FKPE 065-HG
95	70	FKPE 095-HG

Connector

Height in mm	Item no.
48	FKPV 048-HG
65	FKPV 065-HG
95	FKPV 095-HG



Length: 3.00 m - with longitudinal hole

External height in mm	Internal height in mm	Item no.
48	23	FKP 048-GM-300
65	40	FKP 065-GM-300
95	70	FKP 095-GM-300



RAL 9007
grey metallic

External corners

External height in mm	Internal height in mm	Item no.
48	23	FKPE 048-GM
65	40	FKPE 065-GM
95	70	FKPE 095-GM

Connector

Height in mm	Item no.
48	FKPV 048-GM
65	FKPV 065-GM
95	FKPV 095-GM

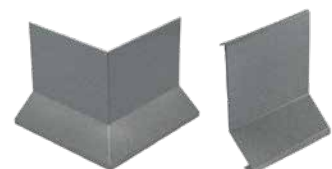

These profiles require connectors for the corner combination (profile and corner).

fuma // OUTDOOR – GRAVEL BED BEARING

stone slabs, concrete slabs/terrace slabs

Circle

Joint width in mm	Joint web height in mm	Item no.
3	15	KLA-G 0315

Pieces / box: 10

Semicircle

Joint width in mm	Joint web height in mm	Item no.
3	15	KLA-H 0315

Pieces / box: 10

Corner

Joint width in mm	Joint web height in mm	Item no.
4	18	KLA-E 0418

Pieces / box: 10

→ Support height: 3.5 mm

→ Diameter: 146 mm

Easy to lay directly on water-permeable substrates such as gravel, sand and chippings. The slabs lie horizontally and vertically on all loose, applied substrates safely, stable and non-slip. No tilting of the laid slabs. Safe and non-slip installation.



fuma // OUTDOOR – TILE SPACERS HARD PLASTIC

for stone slabs, concrete slabs/terrace slabs

Without bottom

Joint width in mm	Height in mm	Item no.
3	10	FGK 0310
3	20	FGK 0320
4	20	FGK 0420
5	20	FGK 0520
8	20	FGK 0820
10	20	FGK 1020

Pieces / box: 100

With bottom

Joint width in mm	Joint web height in mm	Item no.
3	10	FGK/B 0310

Pieces / box: 100

For easy laying of stone slabs, concrete slabs or terrace slabs with defined and even joints. Can also be used as a T-piece for the edge area due to a predetermined breaking point. Simple, cost-effective installation, as no additional tools/work equipment are required. Weather/ageing resistant and environmentally friendly, as 100% recyclable.



fuma // OUTDOOR – PLATE / TERRACE BEARINGS

with accessories

Joint width in mm	Joint web height in mm	Total height in mm	Item no.
3	10	20	GLA-G 1020/3
4	18	28	GLA-G 1028/4

Pieces / box: 50

Compensating washer

Thickness in mm	Item no.
2.5	AGS 117

Pieces / box: 50

The large contact surface provides high pressure stability and prevents the plates from tilting. Noise absorbing and good water drainage due to nubbed bottom page. Suitable shims can be used to compensate for differences in height. High-quality, flexible black rubber material (resistant to weathering and ageing). No frost damage due to flexible separation of the plates from the substrate.

→ **Diameter:** 117 mm→ **Disc thickness:** 2.5 mm

Compensating washer can be used as height compensating washer for gravel and stilted bearings as well as for slab/terrace bearings.

fuma // OUTDOOR – TERRACE / BALCONY PEDESTAL BEARING INCL. EXTENSION PIECE

with accessories

Fixed

Height in mm	Item no.	Pieces / Box
32 - 38	FST 60-01/30-F	80
38 - 50	FST 60-02/40-F	70
50 - 75	FST 60-03/55-F	50
73 - 110	FST 60-04/75-F	40

Self-levelling

Height in mm	Item no.	Pieces / Box
42 - 48	FST 70-01/30-S	70
48 - 60	FST 70-02/40-S	60
60 - 85	FST 70-03/55-S	45
83 - 120	FST 70-04/75-S	35

Extension socket

Height in mm	Item no.	Pieces / Box
50	FST 67-STU/50	10
75	FST 67-STU/75	10

Rubber support

Height in mm	Item no.	Pieces / Box
1	FST 60-GUM/01	100

Installation wrench

Item no.
Installation wrench

For joint width 3 mm**Diameter:** Base plate: 200 mm / head piece: 108 mm.**Material thickness:** 3 mm**FIXED****For joint width 3 mm****Diameter:** Base plate: 200 mm / head piece: 108 mm.**Material thickness:** 3 mm**SELF-LEVELLING**

The installation wrench makes working with our pedestal bearings much easier. The wrench is attached to the side of the pedestal bearing head. This allows the pedestal bearing head to be turned and adjusted in height.

DRAINAGE CHANNELS

PAGE 82 - 97





“Drainage channels are used to drain rainwater in a targeted manner. They prevent water from standing on pavements, driveways or near buildings. In this way, they ensure that areas remain dry and safe.”

ARTEM HEINZ

part of the fuma-Bautec team
since 2023

// MAGNELIS® COATING

Not all hot-dip galvanized is the same

Our fuma//CHANNEL-items made of steel have a Magnelis® coating.

Exception: mesh gratings.

// ADVANTAGES

- **best corrosion resistance:**
up to 10 times better than galvanized steel
- **best resistance in particularly hard and harsh environments**
- **environmentally friendly**
- **self-repairing protection for cut edges**

Superior corrosion resistance

Nothing offers better protection in chloride or ammonia-containing environments than Magnelis®. Due to its unique chemical composition, Magnelis® provides significantly better corrosion protection than standard hot-dip galvanized steel.

Standard zinc coatings have the major disadvantage that the coating is often damaged in ammonia-containing environments. With Magnelis® this damage is seven times less. In addition, Magnelis® guarantees longer-lasting active surface protection.

Double protection for cut edges

Magnelis® protects exposed cut edges in two ways, offering unrivalled protection: firstly, the cut edges are aligned with the cathodic protection of the conventional zinc coating. Secondly, Magnelis® provides a magnesium-containing zinc-based protective film that also protects against corrosion.

Particularly intelligent: the nature of this film changes depending on the environment and the properties of the prevailing aluminum and magnesium content.

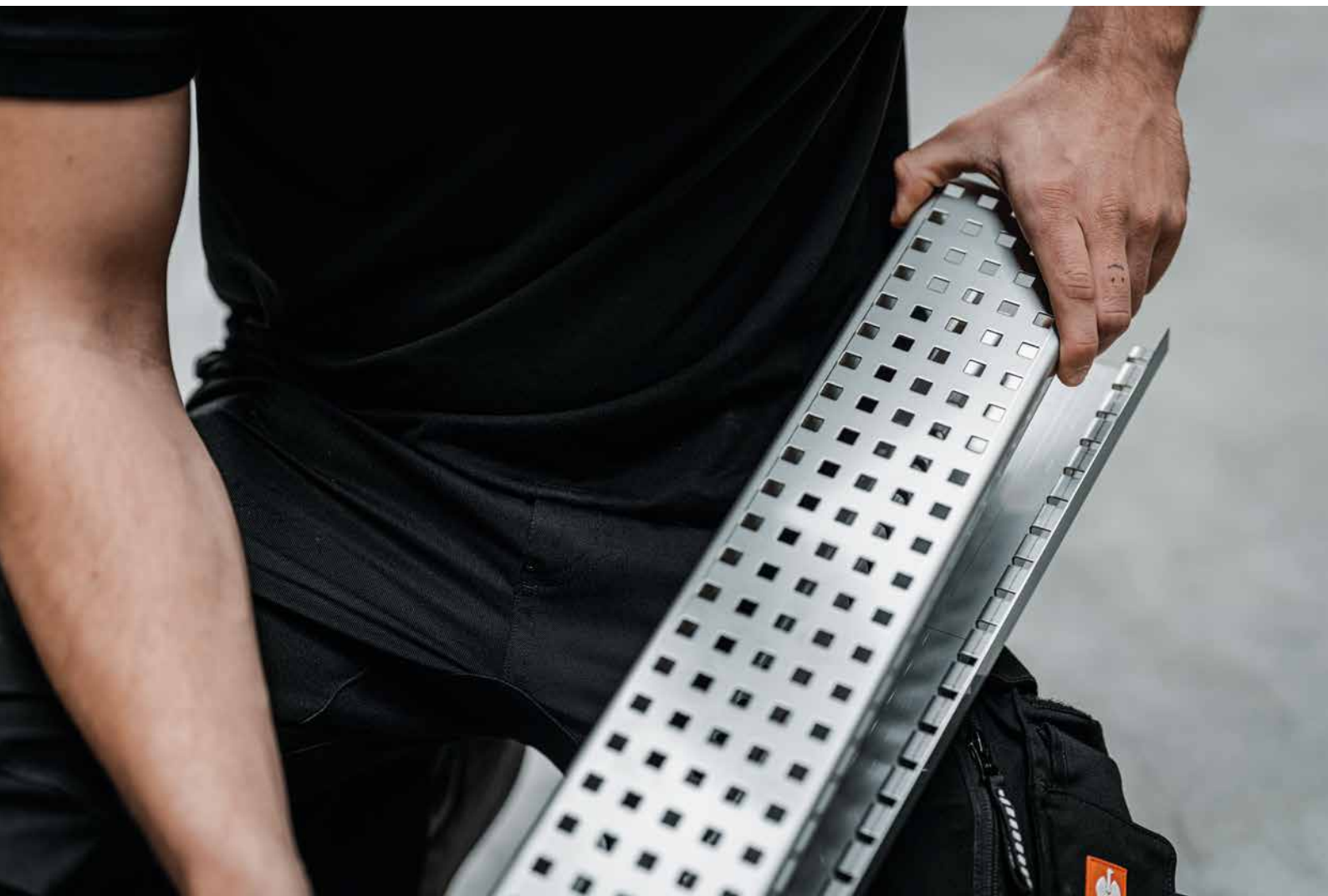

fuma // CHANNEL – GRATING DESIGNS

You can combine these grating designs with our drainage systems.

ROUND PERFORATION

Hole spacing in mm	Diameter in mm
20	8.5

- stainless steel
- hot-dip galvanized steel with Magnelis® coating

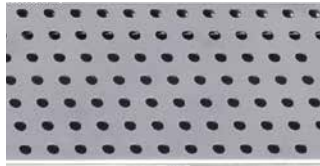
**SQUARE PERFORATION**

Hole spacing in mm	Hole dimensions in mm
20	8 x 8

- stainless steel
- hot-dip galvanized steel with Magnelis® coating

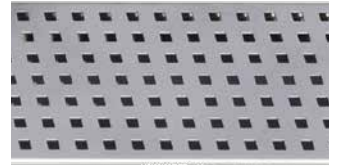
**SLOT PERFORATION RECTANGLE**

Hole spacing in mm	Hole dimensions in mm
20	30 x 5

- stainless steel
- hot-dip galvanized steel with Magnelis® coating

**SLOT PERFORATION NARROW**

Hole spacing in mm	Hole dimensions in mm
20	30 x 5

- stainless steel
- hot-dip galvanized steel with Magnelis® coating

**MESH GRATING**

Mesh size in mm
30 x 10

- stainless steel
- galvanized steel

**LONGITUDINAL MESH GRATING 7 X 7 MM**

Mesh size in mm
100 x 7

- stainless steel



fuma // CHANNEL – DRAINAGE CHANNELS STABILO-FIX

Stainless steel 1.4301/304, length: 1 m, material thickness: 1.5 mm, with perforated 304 grating

Inlet width: 100 mm		Inlet width: 140 mm		Inlet width: 160 mm	
Height in mm	Item no.	Height in mm	Item no.	Height in mm	Item no.
20	DRS 1020-VA	-	-	-	-
40	DRS 1040-VA	40	DRS 1440-VA	40	DRS 1640-VA
50	DRS 1050-VA	50	DRS 1450-VA	50	DRS 1650-VA
60	DRS 1060-VA	60	DRS 1460-VA	60	DRS 1660-VA
80	DRS 1080-VA	80	DRS 1480-VA	80	DRS 1680-VA
100	DRS 1010-VA	100	DRS 1410-VA	100	DRS 1610-VA



Load: Accessible, light rolling loads. Channel bodies and gratings can be manufactured as single parts/individual lengths up to 3.00 m. **Standard length:** 1.00 m. Intermediate dimensions are calculated to full meters.

Appropriate connectors and end pieces are located on page 88.
Please note: Accessories not available for 20 mm heights.

fuma // CHANNEL – DRAINAGE CHANNELS STABILO-FIX

Hot-dip galvanized steel with Magnelis® coating, length: 1 m, material thickness: 1.5 mm, with perforated grating

Inlet width: 100 mm		Inlet width: 140 mm		Inlet width: 160 mm	
Height in mm	Item no.	Height in mm	Item no.	Height in mm	Item no.
20	DRS 1020-ST	-	-	-	-
40	DRS 1040-ST	40	DRS 1440-ST	40	DRS 1640-ST
50	DRS 1050-ST	50	DRS 1450-ST	50	DRS 1650-ST
60	DRS 1060-ST	60	DRS 1460-ST	60	DRS 1660-ST
80	DRS 1080-ST	80	DRS 1480-ST	80	DRS 1680-ST
100	DRS 1010-ST	100	DRS 1410-ST	100	DRS 1610-ST



Load: Accessible, light rolling loads. Channel bodies and gratings can be manufactured as single parts/individual lengths up to 3.00 m. **Standard length:** 1.00 m. Intermediate dimensions are calculated to full meters.

Appropriate connectors and end pieces are located on page 88.
Please note: Accessories not available for 20 mm heights.

// GRATING DESIGNS SUITABLE FOR DRS



Round perforation (Standard)



Square perforation



Slot perforation (narrow)



Slot perforation rectangle

fuma // CHANNEL – DRAINAGE CHANNELS STABILO-FIX

Stainless steel 1.4301/304, length: 1 m, material thickness: 1.5 mm,
with 304 mesh grating 30 x 10 mm

Inlet width: 100 mm		Inlet width: 140 mm		Inlet width: 160 mm	
Height in mm	Item no.	Height in mm	Item no.	Height in mm	Item no.
40	DMR 1040-VA	40	DMR 1440-VA	40	DMR 1640-VA
50	DMR 1050-VA	50	DMR 1450-VA	50	DMR 1650-VA
60	DMR 1060-VA	60	DMR 1460-VA	60	DMR 1660-VA
80	DMR 1080-VA	80	DMR 1480-VA	80	DMR 1680-VA
100	DMR 1010-VA	100	DMR 1410-VA	100	DMR 1610-VA



Load: Accessible, light rolling loads. The channel body can be manufactured as a single part/individual length up to 3.00 m.
Standard length: 1.00 m. Intermediate dimensions are calculated to full meters. The mesh gratings are supplied in 1.00 m lengths.

Appropriate connectors and end pieces are located on page 88.

fuma // CHANNEL – DRAINAGE CHANNELS STABILO-FIX

Hot-dip galvanized steel with Magnelis® coating, length: 1 m, material thickness: 1.5 mm,
with mesh grating 30 x 10 mm

Inlet width: 100 mm		Inlet width: 140 mm		Inlet width: 160 mm	
Height in mm	Item no.	Height in mm	Item no.	Height in mm	Item no.
40	DMR 1040-ST	40	DMR 1440-ST	40	DMR 1640-ST
50	DMR 1050-ST	50	DMR 1450-ST	50	DMR 1650-ST
60	DMR 1060-ST	60	DMR 1460-ST	60	DMR 1660-ST
80	DMR 1080-ST	80	DMR 1480-ST	80	DMR 1680-ST
100	DMR 1010-ST	100	DMR 1410-ST	100	DMR 1610-ST



Load: Accessible, light rolling loads. The channel body can be manufactured as a single part/individual length up to 3.00 m.
Standard length: 1.00 m. Intermediate dimensions are calculated to full meters. The mesh gratings are supplied in 1.00 m lengths.

Appropriate connectors and end pieces are located on page 88.

fuma // CHANNEL - DRAINAGE CHANNELS STABILO-FIX

Stainless steel 1.4301/304, length: 1 m, material thickness: 1.5 mm, with longitudinal mesh grating 7 x 7 mm

Inlet width: 100 mm		Inlet width: 140 mm		Inlet width: 160 mm	
Height in mm	Item no.	Height in mm	Item no.	Height in mm	Item no.
40	DLS 1040-VA	40	DLS 1440-VA	40	DLS 1640-VA
50	DLS 1050-VA	50	DLS 1450-VA	50	DLS 1650-VA
60	DLS 1060-VA	60	DLS 1460-VA	60	DLS 1660-VA
80	DLS 1080-VA	80	DLS 1480-VA	80	DLS 1680-VA
100	DLS 1010-VA	100	DLS 1410-VA	100	DLS 1610-VA



Load: Accessible, light rolling loads. The channel body can be manufactured as a single part/individual length up to 3.00 m.
Standard length: 1.00 m. Intermediate dimensions are calculated to full meters.

Appropriate connectors and end pieces are located below.

fuma // CHANNEL - ACCESSORIES

suitable for all **Stabilo-Fix** drainage channels

Connector (1 pair)

Material	Item no.
Stainless steel	DR-S-VB-VA
Hot-dip galvanized steel	DR-S-VB-ST

**End piece**

Material	Item no.
Stainless steel	DR-S-ES-100-VA
Hot-dip galvanized steel	DR-S-ES-140-ST



fuma // CHANNEL - DRAINAGE CHANNELS FUTURO

Stainless steel 1.4301/304, length: 1 m, material thickness: 1.5 mm, on support legs, with perforated grating

Inlet width: 100 mm		Inlet width: 140 mm	
Height in mm	Item no.	Height in mm	Item no.
55 - 80	DRF 1055-VA	55 - 80	DRF 1455-VA
85 - 110	DRF 1085-VA	85 - 110	DRF 1485-VA

Load: Accessible, light rolling loads. Channel bodies and gratings can be manufactured as single parts/individual lengths up to 3.00 m. **Standard length:** 1.00 m. Intermediate dimensions are calculated to full meters.

Appropriate connectors, end pieces and locking devices are located on page 91.

**fuma // CHANNEL - DRAINAGE CHANNELS FUTURO**

Hot-dip galvanized steel with Magnelis® coating, length: 1 m, material thickness: 1.5 mm, on support legs, with perforated grating

Inlet width: 100 mm		Inlet width: 140 mm	
Height in mm	Item no.	Height in mm	Item no.
55 - 80	DRF 1055-ST	55 - 80	DRF 1455-ST
85 - 110	DRF 1085-ST	85 - 110	DRF 1485-ST

Load: Accessible, light rolling loads. Channel bodies and gratings can be manufactured as single parts/individual lengths up to 3.00 m. **Standard length:** 1.00 m. Intermediate dimensions are calculated to full meters.

Appropriate connectors, end pieces and locking devices are located on page 91.

**// GRATING DESIGNS** SUITABLE FOR DRF

Round perforation (Standard)



Square perforation



Slot perforation (narrow)



Slot perforation rectangle

fuma // CHANNEL - DRAINAGE CHANNELS FUTURO

Stainless steel 1.4301/304, length: 1 m, material thickness: 1.5 mm, on support legs, with mesh grating 30 x 10 mm

Inlet width: 100 mm		Inlet width: 140 mm	
Height in mm	Item no.	Height in mm	Item no.
55 - 80	FMR 1055-VA	55 - 80	FMR 1455-VA
85 - 110	FMR 1085-VA	85 - 110	FMR 1485-VA

Load: Accessible, light rolling loads. The channel body can be manufactured as a single part/individual length up to 3.00 m. **Standard length:** 1.00 m. Intermediate dimensions are calculated to full meters. The mesh gratings are supplied in 1.00 m lengths.

Appropriate connectors, end pieces and locking devices are located on page 91.

**fuma // CHANNEL - DRAINAGE CHANNELS FUTURO**

Hot-dip galvanized steel with Magnelis® coating, length: 1 m, material thickness: 1.5 mm, on support legs, with mesh grating 30 x 10 mm

Inlet width: 100 mm		Inlet width: 140 mm	
Height in mm	Item no.	Height in mm	Item no.
55 - 80	FMR 1055-ST	55 - 80	FMR 1455-ST
85 - 110	FMR 1085-ST	85 - 110	FMR 1485-ST

Load: Accessible, light rolling loads. The channel body can be manufactured as a single part/individual length up to 3.00 m. **Standard length:** 1.00 m. Intermediate dimensions are calculated to full meters. The mesh gratings are supplied in 1.00 m lengths.

Appropriate connectors, end pieces and locking devices are located on page 91.



fuma // CHANNEL - DRAINAGE CHANNELS FUTURO

Stainless steel 1.4301/304, length: 1 m, material thickness: 1.5 mm, on support legs, with longitudinal mesh grating 7 x 7 mm

Inlet width: 100 mm		Inlet width: 140 mm	
Height in mm	Item no.	Height in mm	Item no.
55 - 80	FLS 1055-VA	55 - 80	FLS 1455-VA
85 - 110	FLS 1085-VA	85 - 110	FLS 1485-VA

Load: Accessible, light rolling loads. The channel body can be manufactured as a single part/individual length up to 3.00 m. **Standard length:** 1.00 m. Intermediate dimensions are calculated to full meters.

Appropriate connectors, end pieces and locking devices are located below.

**fuma // CHANNEL - ACCESSORIES**

suitable for all Futuro drainage channels

Connector (1 pair)

Material	Item no.
Stainless steel	DR-F-VB-VA
Hot-dip galvanized steel	DR-F-VB-ST

**End piece**

Material	Inlet width in mm	Item no.
Stainless steel	100	DR-F-ES-100-VA
Stainless steel	140	DR-F-ES-140-VA
Hot-dip galvanized steel	100	DR-F-ES-100-ST
Hot-dip galvanized steel	140	DR-F-ES-140-ST

**Grate locking device**

Material	Inlet width in mm	Item no.
Stainless steel	100	DR-F-RV-100-VA
Stainless steel	140	DR-F-RV-140-VA
Hot-dip galvanized steel	100	DR-F-RV-100-ST
Hot-dip galvanized steel	140	DR-F-RV-140-ST



fuma // CHANNEL – LINE DRAINAGE CHANNELS STABILO-FIX

Stainless steel 1.4301/304, length: 1 m, material thickness: 1.5 mm, with perforated grating

Inlet width: 100 mm		Inlet width: 140 mm	
Height in mm	Item no.	Height in mm	Item no.
20	DRS-LI 1020-VA	-	-
40	DRS-LI 1040-VA	40	DRS-LI 1440-VA
50	DRS-LI 1050-VA	50	DRS-LI 1450-VA
80	DRS-LI 1080-VA	80	DRS-LI 1480-VA
100	DRS-LI 1010-VA	100	DRS-LI 1410-VA

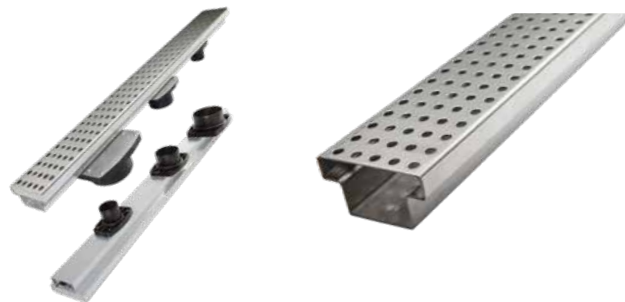

Load: Accessible, light rolling loads. Channel bodies and gratings can be manufactured as single parts/individual lengths up to 3.00 m. **Standard length:** 1.00 m. Intermediate dimensions are calculated to full meters.

Appropriate connectors and end pieces are located on page 93.

fuma // CHANNEL – LINE DRAINAGE CHANNELS STABILO-FIX

Hot-dip galvanized steel with Magnelis® coating, length: 1 m, material thickness: 1.5 mm, with perforated grating

Inlet width: 100 mm		Inlet width: 140 mm	
Height in mm	Item no.	Height in mm	Item no.
20	DRS-LI 1020-ST	-	-
40	DRS-LI 1040-ST	40	DRS-LI 1440-ST
50	DRS-LI 1050-ST	50	DRS-LI 1450-ST
80	DRS-LI 1080-ST	80	DRS-LI 1480-ST
100	DRS-LI 1010-ST	100	DRS-LI 1410-ST



Load: Accessible, light rolling loads. Channel bodies and gratings can be manufactured as single parts/individual lengths up to 3.00 m. **Standard length:** 1.00 m. Intermediate dimensions are calculated to full meters.

Appropriate connectors and end pieces are located on page 93.

// GRATING DESIGNS

SUITABLE FOR DRS-LI



Round perforation (Standard)



Square perforation



Slot perforation (narrow)



Slot perforation rectangle

fuma // CHANNEL – LINE DRAINAGE CHANNELS STABILO-FIX

Stainless steel 1.4301/304, length: 1 m, material thickness: 1.5 mm, with mesh grating 30 x 10 mm

Inlet width: 100 mm		Inlet width: 140 mm	
Height in mm	Item no.	Height in mm	Item no.
40	DMR-LI 1040-VA	40	DMR-LI 1440-VA
50	DMR-LI 1050-VA	50	DMR-LI 1450-VA
80	DMR-LI 1080-VA	80	DMR-LI 1480-VA
100	DMR-LI 1010-VA	100	DMR-LI 1410-VA



Load: Accessible, light rolling loads. The channel body can be manufactured as a single part/individual length up to 3.00 m. **Standard length:** 1.00 m. Intermediate dimensions are calculated to full meters. The mesh gratings are supplied in 1.00 m lengths.

Appropriate connectors and end pieces are located below.

fuma // CHANNEL – LINE DRAINAGE CHANNELS STABILO-FIX

Hot-dip galvanized steel with Magnelis® coating, length: 1 m, material thickness: 1.5 mm, with mesh grating 30 x 10 mm

Inlet width: 100 mm		Inlet width: 140 mm	
Height in mm	Item no.	Height in mm	Item no.
40	DMR-LI 1040-ST	40	DMR-LI 1440-ST
50	DMR-LI 1050-ST	50	DMR-LI 1450-ST
80	DMR-LI 1080-ST	80	DMR-LI 1480-ST
100	DMR-LI 1010-ST	100	DMR-LI 1410-ST



Load: Accessible, light rolling loads. The channel body can be manufactured as a single part/individual length up to 3.00 m. **Standard length:** 1.00 m. Intermediate dimensions are calculated to full meters. The mesh gratings are supplied in 1.00 m lengths.

Appropriate connectors and end pieces are located below.

fuma // CHANNEL – ACCESSORIES

suitable for all line drainage channels

Connector / U-profile		End piece	
Material	Item no.	Material	Item no.
Stainless steel	LI-VB-VA	Stainless steel	LI-ES-VA
Hot-dip galvanized steel	LI-VB-ST	Hot-dip galvanized steel	LI-ES-ST



Item no.
AB-KUNST DN50
AB-KUNST DN70
AB-KUNST DN100

The positioning of the drain outlet can be freely selected according to specifications. The nozzle is riveted underneath the channel. On request, drain nozzles made of stainless steel or galvanized steel can also be welded to the underside according to specifications. Price on request.



fuma // CHANNEL - DRAINAGE GULLIES HYDRO

Stainless steel 1.4301/304, material thickness: 1.5 mm, with perforated grate

Height adjustment in mm: 54 - 69

Dimensions in mm	Item no.
250 x 250	G-DRH 2556-VA
400 x 400	G-DRH 4056-VA
500 x 500	G-DRH 5056-VA

Height adjustment in mm: 70 - 100

Dimensions in mm	Item no.
250 x 250	G-DRH 2571-VA
400 x 400	G-DRH 4071-VA
500 x 500	G-DRH 5071-VA

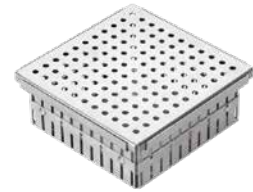

Load: Accessible, light rolling loads, accessible drainage channels on request. In case of problems with the installation height, we deliver screwable base profiles in heights of 30 mm for the drainage gullies according to the format sizes, 60 mm and 90 mm. Prices on request.

fuma // CHANNEL - DRAINAGE GULLIES HYDRO

Hot-dip galvanized steel with Magnelis® coating, material thickness: 1.5 mm, with perforated grate

Height adjustment in mm: 54 - 69

Dimensions in mm	Item no.
250 x 250	G-DRH 2556-ST
400 x 400	G-DRH 4056-ST
500 x 500	G-DRH 5056-ST

Height adjustment in mm: 70 - 100

Dimensions in mm	Item no.
250 x 250	G-DRH 2571-ST
400 x 400	G-DRH 4071-ST
500 x 500	G-DRH 5071-ST



Load: Accessible, light rolling loads, accessible drainage channels on request. In case of problems with the installation height, we deliver screwable base profiles in heights of 30 mm for the drainage gullies according to the format sizes, 60 mm and 90 mm. Prices on request.

// GRATING DESIGNS

SUITABLE FOR G-DRH



Round perforation (Standard)



Square perforation



Slot perforation (narrow)



Slot perforation rectangle

fuma // CHANNEL - DRAINAGE GULLIES HYDRO

Stainless steel 1.4301/304, with longitudinal grating 20 x 3 mm

Height adjustment in mm: 54 - 69

Dimensions in mm	Item no.
250 x 250	G-HLZ 2556-VA
400 x 400	G-HLZ 4056-VA
500 x 500	G-HLZ 5056-VA

Height adjustment in mm: 70 - 100

Dimensions in mm	Item no.
250 x 250	G-HLZ 2571-VA
400 x 400	G-HLZ 4071-VA
500 x 500	G-HLZ 5071-VA

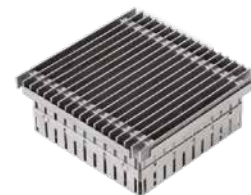

Load: Accessible, light rolling loads, accessible drainage channels on request. In case of problems with the installation height, we deliver screwable base profiles in heights of 30 mm for the drainage gullies according to the format sizes, 60 mm and 90 mm. Prices on request.

fuma // CHANNEL - DRAINAGE GULLIES HYDRO

Stainless steel 1.4301/304, with longitudinal grating 7 x 7 mm

Height adjustment in mm: 54 - 69

Dimensions in mm	Item no.
250 x 250	G-HLS 2556-VA
400 x 400	G-HLS 4056-VA
500 x 500	G-HLS 5056-VA

Height adjustment in mm: 70 - 100

Dimensions in mm	Item no.
250 x 250	G-HLS 2571-VA
400 x 400	G-HLS 4071-VA
500 x 500	G-HLS 5071-VA

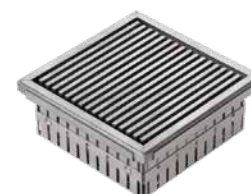

Load: Accessible, light rolling loads, accessible drainage channels on request. In case of problems with the installation height, we deliver screwable base profiles in heights of 30 mm for the drainage gullies according to the format sizes, 60 mm and 90 mm. Prices on request.

fuma // CHANNEL - DRAINAGE GULLIES HYDRO

Stainless steel 1.4301/304, with mesh grating 30 x 10 mm

Height adjustment in mm: 54 - 69

Dimensions in mm	Item no.
250 x 250	G-HMR 2556-VA
400 x 400	G-HMR 4056-VA
500 x 500	G-HMR 5056-VA

Height adjustment in mm: 70 - 100

Dimensions in mm	Item no.
250 x 250	G-HMR 2571-VA
400 x 400	G-HMR 4071-VA
500 x 500	G-HMR 5071-VA



Load: Accessible, light rolling loads, accessible drainage channels on request. In case of problems with the installation height, we deliver screwable base profiles in heights of 30 mm for the drainage gullies according to the format sizes, 60 mm and 90 mm. Prices on request.

fuma // CHANNEL - DRAINAGE GULLIES HYDRO

Hot-dip galvanized steel with Magnelis® coating, with mesh grating 30 x 10 mm (galvanized)

Height adjustment in mm: 54 - 69

Dimensions in mm	Item no.
250 x 250	G-HMR 2556-ST
400 x 400	G-HMR 4056-ST
500 x 500	G-HMR 5056-ST

Height adjustment in mm: 70 - 100

Dimensions in mm	Item no.
250 x 250	G-HMR 2571-ST
400 x 400	G-HMR 4071-ST
500 x 500	G-HMR 5071-ST



Load: Accessible, light rolling loads, accessible drainage channels on request. In case of problems with the installation height, we deliver screwable base profiles in heights of 30 mm for the drainage gullies according to the format sizes, 60 mm and 90 mm. Prices on request.

fuma // CHANNEL - GRAVEL STOP EDGE PROFILES

Stainless steel 1.4301 / 304, material thickness: 1.0 mm, visible edge: 10 mm, fixed construction height

Length: 3.00 m

Height in mm	Item no.	Supporting leg in mm
50	KFED 5010	100
60	KFED 6010	110
70	KFED 7010	100
80	KFED 8012	120
100	KFED 10012	140



Support leg unperforated, on request the Gravel stop edge profiles can be supplied with perforated support leg.

Punched hole: 60 mm diameter, additional price per linear meter = on request.

Attention: When using Gravel stop edge profiles on sealing surfaces, protective measures must be taken in accordance with the regulations.

fuma // CHANNEL - GRAVEL STOP EDGE PROFILES

Aluminum blank, material thickness: 1.5 mm, visible edge: 10 mm, fixed construction height

Length: 3.00 m

Height in mm	Item no.	Supporting leg in mm
50	KFAL 5010	100
60	KFAL 6011	110
70	KFAL 7010	100
80	KFAL 8012	120
100	KFAL 10014	140



Support leg unperforated, on request the Gravel stop edge profiles can be supplied with perforated support leg.

Punched hole: 60 mm diameter, additional price per linear meter = on request.

Attention: When using Gravel stop edge profiles on sealing surfaces, protective measures must be taken in accordance with the regulations.

fuma // CHANNEL – GRAVEL STOP EDGE PROFILES

Stainless steel 1.4301 / 304, material thickness: 1.0 mm, visible edge: 10 mm, height adjustable

Length: 3.00 m

Height in mm	Item no.	Supporting leg in mm
60 - 100	KFED 60100	165

The height-adjustable Gravel stop edge profiles can be adjusted by means of a screw connection. Support leg unperforated, on request the Gravel stop edge profiles can be supplied with perforated support leg.

Punched hole: 60 mm diameter, extra charge per linear meter = on request.

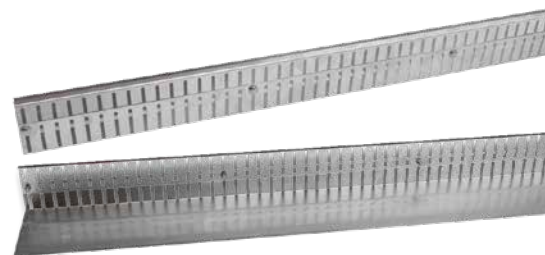
Height adjustment
Example 1Height adjustment
Example 2**fuma // CHANNEL – GRAVEL STOP EDGE PROFILES**

Aluminum blank, material thickness: 1.5 mm, visible edge: 10 mm, height adjustable

Length: 3.00 m

Height in mm	Item no.	Supporting leg in mm
60 - 100	KFAL 60100	175

The height-adjustable Gravel stop edge profiles can be adjusted by means of a screw connection. Support leg unperforated, on request the Gravel stop edge profiles can be supplied with perforated support leg.

Punched hole: 60 mm diameter, extra charge per linear meter = on request.

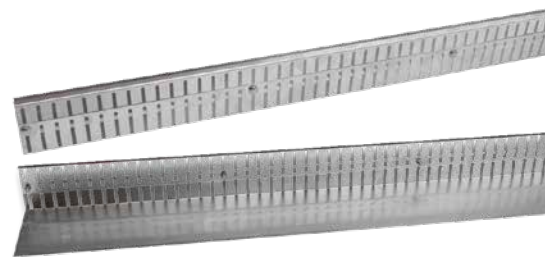
Height adjustment
Example 1Height adjustment
Example 2



EXPANSION JOINT PROFILES

PAGE 98 - 113

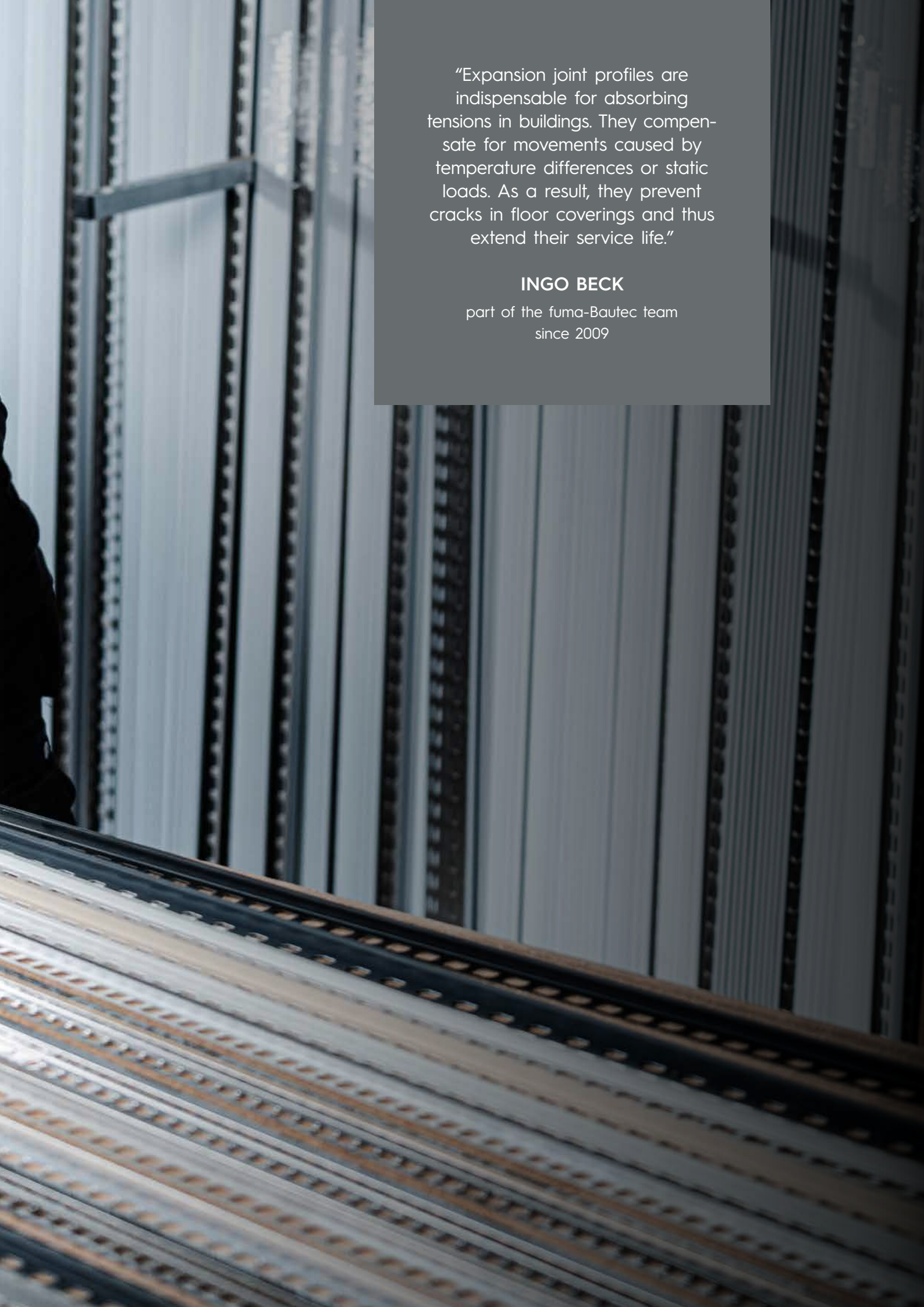

“Expansion joint profiles are indispensable for absorbing tensions in buildings. They compensate for movements caused by temperature differences or static loads. As a result, they prevent cracks in floor coverings and thus extend their service life.”

INGO BECK

part of the fuma-Bautec team
since 2009

fuma // MOVE - THIN-BED PROFILES

Stainless steel 1.4301/304, with EPDM infill,
 visible widths: **8 mm** (heights 3 - 15 mm) / **9 mm** (heights 17 - 30 mm)

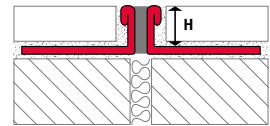

Length: 2.50 m

Height in mm	Item no.
3.0	FDE 030-G-250
4.5	FDE 045-G-250
6.0	FDE 060-G-250
8.0	FDE 080-G-250
10.0	FDE 100-G-250
11.0	FDE 110-G-250
12.5	FDE 125-G-250
15.0	FDE 150-G-250
17.0	FDE 170-G-250
20.0	FDE 200-G-250
22.0	FDE 220-G-250
25.0	FDE 250-G-250
30.0	FDE 300-G-250



Length: 2.50 m

Height in mm	Item no.
3.0	FDE 030-SW-250
4.5	FDE 045-SW-250
6.0	FDE 060-SW-250
8.0	FDE 080-SW-250
10.0	FDE 100-SW-250
11.0	FDE 110-SW-250
12.5	FDE 125-SW-250
15.0	FDE 150-SW-250
17.0	FDE 170-SW-250
20.0	FDE 200-SW-250
22.0	FDE 220-SW-250
25.0	FDE 250-SW-250
30.0	FDE 300-SW-250



Length: 2.50 m

Height in mm	Item no.
3.0	FDE 030-BG-250
4.5	FDE 045-BG-250
6.0	FDE 060-BG-250
8.0	FDE 080-BG-250
10.0	FDE 100-BG-250
11.0	FDE 110-BG-250
12.5	FDE 125-BG-250
15.0	FDE 150-BG-250
17.0	FDE 170-BG-250
20.0	FDE 200-BG-250
22.0	FDE 220-BG-250
25.0	FDE 250-BG-250
30.0	FDE 300-BG-250



Available on request.

Available on request.

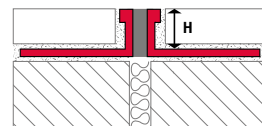

fuma // MOVE - THIN-BED PROFILES

Aluminum, with EPDM infill, visible width: 10 mm

Length: 2.50 m

Height in mm	Item no.
3.0	FDA 030-G-250
4.5	FDA 045-G-250
6.0	FDA 060-G-250
8.0	FDA 080-G-250
10.0	FDA 100-G-250
11.0	FDA 110-G-250
12.5	FDA 125-G-250
15.0	FDA 150-G-250
16.0	FDA 160-G-250
18.5	FDA 185-G-250
20.0	FDA 200-G-250
22.0	FDA 220-G-250
25.0	FDA 250-G-250
30.0	FDA 300-G-250

infill: grey



Length: 2.50 m

Height in mm	Item no.
3.0	FDA 030-SW-250
4.5	FDA 045-SW-250
6.0*	FDA 060-SW-250
8.0*	FDA 080-SW-250
10.0*	FDA 100-SW-250
11.0*	FDA 110-SW-250
12.5*	FDA 125-SW-250
15.0*	FDA 150-SW-250
16.0*	FDA 160-SW-250
18.5*	FDA 185-SW-250
20.0*	FDA 200-SW-250
22.0*	FDA 220-SW-250
25.0*	FDA 250-SW-250
30.0*	FDA 300-SW-250

infill: black



Length: 2.50 m

Height in mm	Item no.
3.0	FDA 030-BG-250
4.5	FDA 045-BG-250
6.0*	FDA 060-BG-250
8.0*	FDA 080-BG-250
10.0*	FDA 100-BG-250
11.0*	FDA 110-BG-250
12.5*	FDA 125-BG-250
15.0*	FDA 150-BG-250
16.0*	FDA 160-BG-250
18.5*	FDA 185-BG-250
20.0*	FDA 200-BG-250
22.0*	FDA 220-BG-250
25.0*	FDA 250-BG-250
30.0*	FDA 300-BG-250

infill: beige



* Available on request.

* Available on request.

fuma // MOVE - THIN-BED PROFILES

Hard-soft PVC, visible width: 8 mm, with narrow support leg

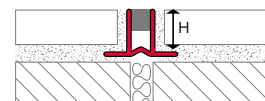

Length: 2.50 m

Height in mm	Item no.
8.0	FDB 080/SA-250
10.0	FDB 100/SA-250
12.5	FDB 125/SA-250
15.0	FDB 150/SA-250

light grey
(similar to
RAL 7035)



fuma // MOVE - THIN-BED PROFILES

Hard-soft PVC, visible width: 8 mm

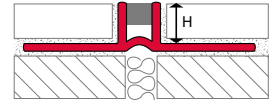

Length: 2.50 m

Height in mm	Item no.
6.0	FDB 060-250-HG
8.0	FDB 080-250-HG
10.0	FDB 100-250-HG
12.5	FDB 125-250-HG
15.0	FDB 150-250-HG



Length: 2.50 m

Height in mm	Item no.
-	-
8.0	FDB 080-250-DG
10.0	FDB 100-250-DG
12.5	FDB 125-250-DG
15.0	FDB 150-250-DG



Length: 2.50 m

Height in mm	Item no.
6.0	FDB 060-250-SW
8.0	FDB 080-250-SW
10.0	FDB 100-250-SW
12.5	FDB 125-250-SW
15.0	FDB 150-250-SW



Length: 2.50 m

Height in mm	Item no.
6.0	FDB 060-250-BG
8.0	FDB 080-250-BG
10.0	FDB 100-250-BG
12.5	FDB 125-250-BG
15.0	FDB 150-250-BG

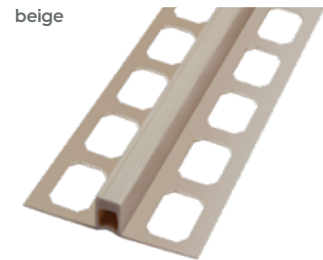

Length: 2.50 m

Height in mm	Item no.
-	-
8.0	FDB 080-250-ZG
10.0	FDB 100-250-ZG
12.5	FDB 125-250-ZG
15.0	FDB 150-250-ZG



fuma // MOVE - THIN-BED PROFILES

Hard-soft PVC, visible width: 5 mm

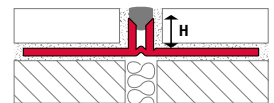

Length: 2.50 m

Height in mm	Item no.
8.0	FDS 080-250-HG
10.0	FDS 100-250-HG
12.5	FDS 125-250-HG



Length: 2.50 m

Height in mm	Item no.
8.0	FDS 080-250-DG
10.0	FDS 100-250-DG
12.5	FDS 125-250-DG



Length: 2.50 m

Height in mm	Item no.
8.0	FDS 080-250-ZG
10.0	FDS 100-250-ZG
12.5	FDS 125-250-ZG



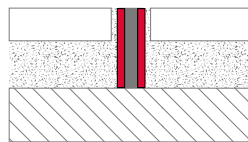

fuma // MOVE - THICK-BED PROFILES

Stainless steel 1.4301/304, EPDM infill,
material thickness: 1 mm, infill width: 8 mm, visible width: 10 mm

Length: 2.50 m

Height in mm	Item no.
20.0	FSE 020-SW-250
30.0	FSE 030-SW-250
40.0	FSE 040-SW-250
50.0	FSE 050-SW-250

infill: black

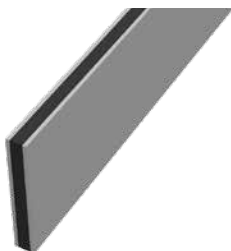

Length: 2.50 m

Height in mm	Item no.
20.0	FSE 020-G-250
30.0	FSE 030-G-250
40.0	FSE 040-G-250
50.0	FSE 050-G-250

infill: grey

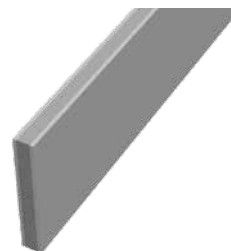

Length: 2.50 m

Height in mm	Item no.
20.0	FSE 020-BG-250
30.0	FSE 030-BG-250
40.0	FSE 040-BG-250
50.0	FSE 050-BG-250

infill: beige

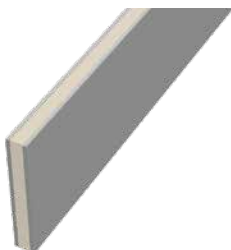

Load: Car, truck, hand pallet truck, forklift truck (no continuous use). The profiles are designed for the use of plastic wheels, pneumatic wheels or solid rubber wheels. Not suitable for use with steel wheels.
Delivery time on request.

fuma // MOVE - THICK-BED PROFILES

Aluminum, EPDM infill,
material thickness: 1 mm, infill width: 8 mm, visible width: 10 mm

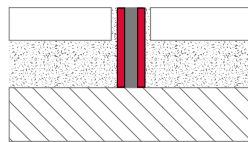

Length: 2.50 m

Height in mm	Item no.
20.0	FSA 020-SW-250
30.0	FSA 030-SW-250
40.0	FSA 040-SW-250
50.0	FSA 050-SW-250

infill: black

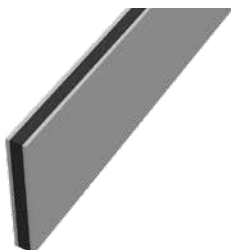

Length: 2.50 m

Height in mm	Item no.
20.0	FSA 020-G-250
30.0	FSA 030-G-250
40.0	FSA 040-G-250
50.0	FSA 050-G-250

infill: grey

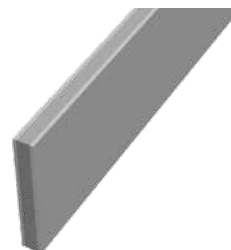

Length: 2.50 m

Height in mm	Item no.
20.0	FSA 020-BG-250
30.0	FSA 030-BG-250
40.0	FSA 040-BG-250
50.0	FSA 050-BG-250

infill: beige

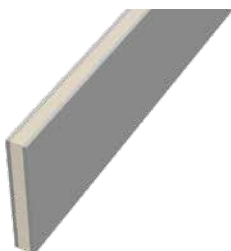

Load: Car, truck, hand pallet truck, forklift truck (no continuous use). The profiles are designed for the use of plastic wheels, pneumatic wheels or solid rubber wheels. Not suitable for use with steel wheels.
Delivery time on request.

fuma // MOVE - THICK-BED PROFILES

Hard-soft PVC, visible width: 10 mm

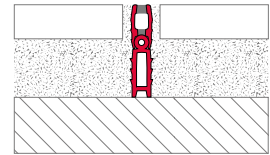

Length: 2.50 m

Height in mm	Item no.
45.0	ZD 4550-250

grey / grey



Length: 2.50 m

Height in mm	Item no.
45.0	ZD 4555-250

grey / transparent



fuma // MOVE - THICK-BED PROFILES

Hard-soft PVC, visible width: 8 mm

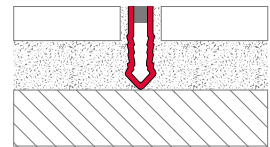

Length: 2.50 m

Height in mm	Item no.
30.0	ED 3000-HG-250
40.0	ED 4000-HG-250
50.0	ED 5000-HG-250
65.0	ED 6500-HG-250

infill: grey



Length: 2.50 m

Height in mm	Item no.
30.0	ED 3000-SW-250
40.0	ED 4000-SW-250
50.0	ED 5000-SW-250
-	-

infill: black



Length: 2.50 m

Height in mm	Item no.
-	-
40.0	ED 4000-DG-250
50.0	ED 5000-DG-250
-	-

infill: dark grey



Length: 2.50 m

Height in mm	Item no.
30.0	ED 3000-BG-250
40.0	ED 4000-BG-250
50.0	ED 5000-BG-250
-	-

infill: beige



fuma // MOVE – FIELD LIMITATION JOINT PROFILES

Aluminum, with cell rubber infill, for vibrating floors, tile and screed surfaces, visible width: 10 mm

Length: 4.00 m

Height in mm	Item no.
300	FAL 1030/ALU-400
400	FAL 1040/ALU-400
500	FAL 1050/ALU-400

→ Joint width: up to 10 mm

→ Joint tolerance: +/- 2.0 mm

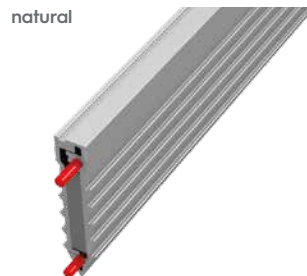

Load: Car, truck, hand pallet truck, forklift truck. No continuous use. Good anchoring due to serrated side walls. The individual profile lengths are connected at the same height and flush by means of enclosed plug-in stainless steel connecting pins.

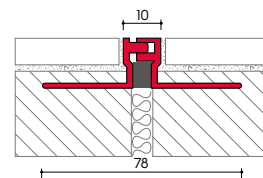

fuma // MOVE – FIELD LIMITATION JOINT PROFILES

Aluminum, for floor coverings from 3 to 17.5 mm, visible width: 10 mm

Length: 2.50 m

Height in mm	Item no.
3.0	FA-SF 030/10-250
4.5	FA-SF 045/10-250
8.0	FA-SF 080/10-250
10.0	FA-SF 100/10-250
11.0	FA-SF 110/10-250
12.5	FA-SF 125/10-250
14.0	FA-SF 140/10-250
15.0	FA-SF 150/10-250
17.5	FA-SF 175/10-250

→ Joint tolerance: +/- 1.5 mm



Load: Passenger car and truck (no continuous use), hand pallet truck, forklift truck with pneumatic and solid rubber tires.

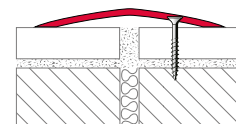

fuma // MOVE – COVER PROFILES

Stainless steel 1.4301 / 304, material thickness: 2 mm

Length: 3.00 m

Visible width in mm	Item no.
60	DG 06020-300
80	DG 08020-300
100	DG 10020-300
120	DG 12020-300



Length: 3.00 m

Visible width in mm	Item no.
60	DS 06020-300
80	DS 08020-300
100	DS 10020-300
120	DS 12020-300



fuma // MOVE - STRUCTURAL EXPANSION JOINT PROFILES
 Aluminum, with PVC infill flush

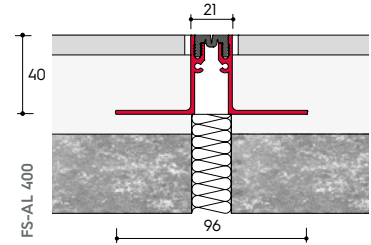

Length: 2.50 m

Height in mm	Item no.	Overall width in mm	Visible width in mm
300	FS-AL 300/S-250	96.0	21.0
400	FS-AL 400/S-250	96.0	21.0
500	FS-AL 500/S-250	96.0	21.0

- **Joint width:**
up to max. 20 mm
- **Joint tolerance:**
+ 3 / - 2 mm



Length: 5.00 m

Height in mm	Item no.	Overall width in mm	Visible width in mm
300	FS-AL 300/S-500	96.0	21.0
400	FS-AL 400/S-500	96.0	21.0
500	FS-AL 500/S-500	96.0	21.0

- **Joint width:**
up to max. 20 mm
- **Joint tolerance:**
+ 3 / - 2 mm

Length: 2.50 m

Height in mm	Item no.	Overall width in mm	Visible width in mm
300	FS-AL 300/G-250	96.0	21.0
400	FS-AL 400/G-250	96.0	21.0
500	FS-AL 500/G-250	96.0	21.0

- **Joint width:**
up to max. 20 mm
- **Joint tolerance:**
+ 3 / - 2 mm



Length: 5.00 m

Height in mm	Item no.	Overall width in mm	Visible width in mm
300	FS-AL 300/G-500	96.0	21.0
400	FS-AL 400/G-500	96.0	21.0
500	FS-AL 500/G-500	96.0	21.0

- **Joint width:**
up to max. 20 mm
- **Joint tolerance:**
+ 3 / - 2 mm

Load: Passenger car, truck, pneumatic forklift truck. No continuous use.

fuma // MOVE – STRUCTURAL EXPANSION JOINT PROFILES
 Aluminum, with PVC infill **grooved** and **flush**

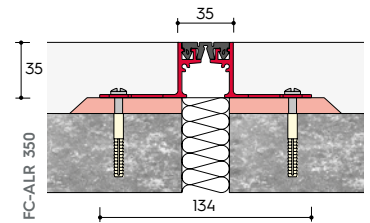

Length: 2.50 m

Height in mm	Item no.	Overall width in mm	Visible width in mm
15.0	FC-ALR 150/S-250	134.0	35.0
35.0	FC-ALR 350/S-250	134.0	35.0
50.0	FC-ALR 500/S-250	134.0	35.0
60.0	FC-ALR 600/S-250	134.0	35.0

- **Joint width:**
up to max. 30 mm
- **Joint tolerance:**
+/- 5 mm



Length: 5.00 m

Height in mm	Item no.	Overall width in mm	Visible width in mm
15.0	FC-ALR 150/S-500	134.0	35.0
35.0	FC-ALR 350/S-500	134.0	35.0
50.0	FC-ALR 500/S-500	134.0	35.0
60.0	FC-ALR 600/S-500	134.0	35.0

- **Joint width:**
up to max. 30 mm
- **Joint tolerance:**
+/- 5 mm

Length: 2.50 m

Height in mm	Item no.	Overall width in mm	Visible width in mm
15.0	FC-ALR 150/G-250	134.0	35.0
35.0	FC-ALR 350/G-250	134.0	35.0
50.0	FC-ALR 500/G-250	134.0	35.0
60.0	FC-ALR 600/G-250	134.0	35.0

- **Joint width:**
up to max. 30 mm
- **Joint tolerance:**
+/- 5 mm



Length: 5.00 m

Height in mm	Item no.	Overall width in mm	Visible width in mm
15.0	FC-ALR 150/G-500	134.0	35.0
35.0	FC-ALR 350/G-500	134.0	35.0
50.0	FC-ALR 500/G-500	134.0	35.0
60.0	FC-ALR 600/G-500	134.0	35.0

- **Joint width:**
up to max. 30 mm
- **Joint tolerance:**
+/- 5 mm

Load: Passenger car, truck, pneumatic forklift truck. No continuous use.

fuma // MOVE – STRUCTURAL EXPANSION JOINT PROFILES
 Aluminum, with PVC infill **smooth** and **flush**

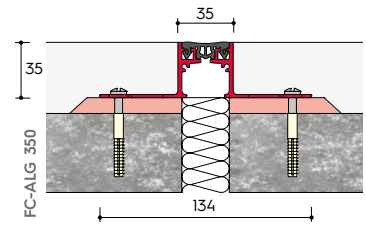

Length: 2.50 m

Height in mm	Item no.	Overall width in mm	Visible width in mm
15.0	FC-ALG 150/S-250	134.0	35.0
35.0	FC-ALG 350/S-250	134.0	35.0
50.0	FC-ALG 500/S-250	134.0	35.0
60.0	FC-ALG 600/S-250	134.0	35.0

- **Joint width:**
up to max. 30 mm
- **Joint tolerance:**
+/- 3 mm



infill:
black

Length: 5.00 m

Height in mm	Item no.	Overall width in mm	Visible width in mm
15.0	FC-ALG 150/S-500	134.0	35.0
35.0	FC-ALG 350/S-500	134.0	35.0
50.0	FC-ALG 500/S-500	134.0	35.0
60.0	FC-ALG 600/S-500	134.0	35.0

- **Joint width:**
up to max. 30 mm
- **Joint tolerance:**
+/- 3 mm

Length: 2.50 m

Height in mm	Item no.	Overall width in mm	Visible width in mm
15.0	FC-ALG 150/G-250	134.0	35.0
35.0	FC-ALG 350/G-250	134.0	35.0
50.0	FC-ALG 500/G-250	134.0	35.0
60.0	FC-ALG 600/G-250	134.0	35.0

- **Joint width:**
up to max. 30 mm
- **Joint tolerance:**
+/- 3 mm



infill:
grey

Length: 5.00 m

Height in mm	Item no.	Overall width in mm	Visible width in mm
15.0	FC-ALG 150/G-500	134.0	35.0
35.0	FC-ALG 350/G-500	134.0	35.0
50.0	FC-ALG 500/G-500	134.0	35.0
60.0	FC-ALG 600/G-500	134.0	35.0

- **Joint width:**
up to max. 30 mm
- **Joint tolerance:**
+/- 3 mm

Load: Passenger car, truck, pneumatic forklift truck. No continuous use.

fuma // MOVE – STRUCTURAL EXPANSION JOINT PROFILES

Solid aluminum, maintenance-free, for high loads

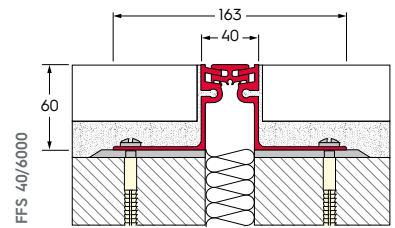

Length: 4.00 m

Height in mm	Item no.	Overall width in mm	Visible width in mm
19	FFS 40/1900-400	173	40
25	FFS 40/2500-400	161	40
35	FFS 40/3500-400	163	40
60	FFS 40/6000-400	163	40

Material: solid aluminum support profile with aluminum fixing bracket (perforated) and textured surface for slip resistance and symmetrical visible surface.

- **Joint width:**
up to max. 35 mm
- **Joint tolerance:**
16 +/- 8 mm
- **Capacity car / truck (DIN 1072):**
300 kN
- **Capacity forklift (DIN 1055):**
70 kN
- **Capacity hard rolls:**
6.5 kgs/mm wheel width



Length: 4.00 m

Height in mm	Item no.	Overall width in mm	Visible width in mm
50	FFS 46/5000-400	165	46

Material: solid aluminum support profile with aluminum fixing bracket (perforated) and textured surface for slip resistance and symmetrical visible surface.

- **Joint width:**
up to max. 35 mm
- **Joint tolerance:**
20 +/- 10 mm
- **Capacity car / truck (DIN 1072):**
300 kN
- **Capacity forklift (DIN 1055):**
70 kN
- **Capacity hard rolls:**
6.5 kgs/mm wheel width



fuma // MOVE – STRUCTURAL EXPANSION JOINT PROFILES

Aluminum, with three-dimensional movement absorption

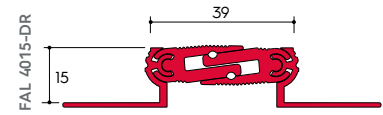

Length: 2.50 m

Height in mm	Item no.	Visible width in mm
8.0	FAL 4008-DR-250	39.0
10.0	FAL 4010-DR-250	39.0
12.5	FAL 4012-DR-250	39.0
15.0	FAL 4015-DR-250	39.0
17.5	FAL 4017-DR-250	39.0

→ **Joint width:**
up to max. 30 mm

→ **Joint tolerance:**
+/- 5 mm

natural



Load: Passenger car, hand pallet truck. No continuous use.

fuma // MOVE – STRUCTURAL EXPANSION JOINT PROFILES

Aluminum, with three-dimensional movement absorption / wall connection

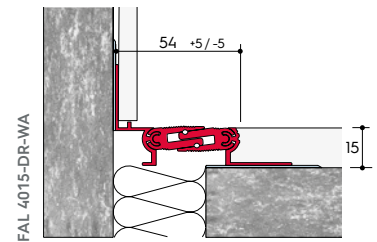

Length: 2.50 m

Height in mm	Item no.	Visible width in mm
8.0	FAL 4008-DR-WA-250	39.0
10.0	FAL 4010-DR-WA-250	39.0
12.5	FAL 4012-DR-WA-250	39.0
15.0	FAL 4015-DR-WA-250	39.0
17.5	FAL 4017-DR-WA-250	39.0

→ **Joint width:**
up to max. 30 mm

→ **Joint tolerance:**
+/- 5 mm

natural



Load: Passenger car, hand pallet truck. No continuous use.

fuma // MOVE - STRUCTURAL EXPANSION JOINT PROFILES

Aluminum, gap-free visible surface, wear-resistant, maintenance-free, durable, visible width: 77 mm

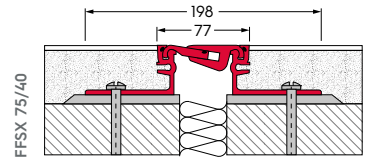

Length: 4.00 m

Height in mm	Item no.	Overall width in mm	Visible width in mm
22	FFSX 75/22-400	198	77
30	FFSX 75/30-400	198	77
40	FFSX 75/40-400	198	77
50	FFSX 75/50-400	198	77
60	FFSX 75/60-400	198	77
80	FFSX 75/80-400	198	77
100	FFSX 75/100-400	198	77

- **Joint width:**
up to max. 50 mm
- **Joint tolerance:**
20 + / -10 mm
- **Capacity car / truck (DIN 1072):**
300 kN
- **Capacity forklift (DIN 1055):**
130 kN
- **Capacity hard rolls:**
10 kgs/mm wheel width



Special features: Solid all-aluminum construction, gap-free visible surface - no risk of contamination. Three-dimensional movement absorption, no danger of slipping due to grooved surface. Splash-proof due to rubber seals. Factory-mounted spacer brackets guarantee profiles set to medium dimensions, thus economical installation and reliable fit of the profile construction. The profile lengths are connected at absolutely the same height by means of connecting pins or by sliding the fastening legs into each other.

fuma // MOVE - STRUCTURAL EXPANSION JOINT PROFILES

Aluminum, gap-free visible surface, wear-resistant, maintenance-free, durable, visible width: 110 mm

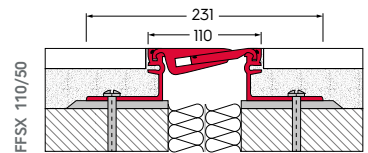

Length: 4.00 m

Height in mm	Item no.	Overall width in mm	Visible width in mm
30	FFSX 110/30-400	231	110
40	FFSX 110/40-400	231	110
50	FFSX 110/50-400	231	110
60	FFSX 110/60-400	231	110
80	FFSX 110/80-400	231	110
100	FFSX 110/100-400	231	110

- **Joint width:**
up to max. 75 mm
- **Joint tolerance:**
30 + / -15 mm
- **Capacity car / truck (DIN 1072):**
300 kN
- **Capacity forklift (DIN 1055):**
130 kN
- **Capacity hard rolls:**
10 kgs/mm wheel width



Special features: Solid all-aluminum construction, gap-free visible surface - no risk of contamination. Three-dimensional movement absorption, no danger of slipping due to grooved surface. Splash-proof due to rubber seals. Factory-mounted spacer brackets guarantee profiles set to medium dimensions, thus economical installation and reliable fit of the profile construction. The profile lengths are connected at absolutely the same height by means of connecting pins or by sliding the fastening legs into each other.

fuma // MOVE – SPORTS FLOOR PROFILES
 Aluminum, with PVC infill **undrilled**

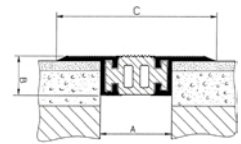

Length: 4.00 m

Item no.	Visible width in mm (C)
FSD 700/3520 SU-400	92

- **Joint width (A):**
45 - 55 mm
- **Joint depth (B):**
min. 19 mm
- **Joint tolerance:**
+/- 5 mm

infill:
black

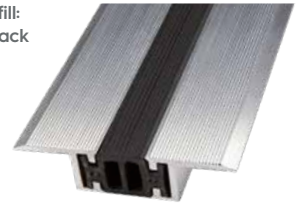

Length: 4.00 m

Item no.	Visible width in mm (C)
FSD 700/3520 GU-400	92

- **Joint width (A):**
45 - 55 mm
- **Joint depth (B):**
min. 19 mm
- **Joint tolerance:**
+/- 5 mm

infill:
grey

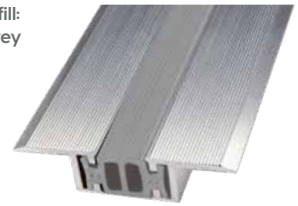

Load: Pedestrians, light rolling loads.

fuma // MOVE – SPORTS FLOOR PROFILES
 Aluminum, with PVC infill **drilled**

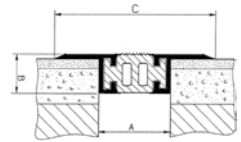

Length: 4.00 m

Item no.	Visible width in mm (C)
FSD 700/3520 SG-400	92

- **Joint width (A):**
45 - 55 mm
- **Joint depth (B):**
min. 19 mm
- **Joint tolerance:**
+/- 5 mm

infill:
black

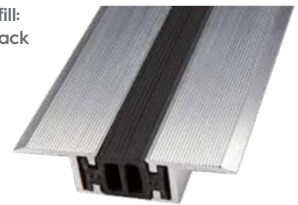

Length: 4.00 m

Item no.	Visible width in mm (C)
FSD 700/3520 GG-400	92

- **Joint width (A):**
45 - 55 mm
- **Joint depth (B):**
min. 19 mm
- **Joint tolerance:**
+/- 5 mm

infill:
grey



Load: Pedestrians, light rolling loads.

fuma // MOVE – SPORTS FLOOR PROFILES

Aluminum, with PVC infill **undrilled**, as wall connection

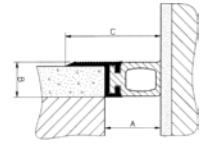

Length: 4.00 m

Item no.	Visible width in mm (C)
FSD 700/35E SU-400	60

→ **Joint width (A):**
30 - 35 mm

infill:
black

→ **Joint depth (B):**
min. 19 mm

→ **Joint tolerance:**
+/- 2 mm

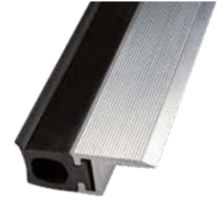

Length: 4.00 m

Item no.	Visible width in mm (C)
FSD 700/35E GU-400	60

→ **Joint width (A):**
30 - 35 mm

infill:
grey

→ **Joint depth (B):**
min. 19 mm

→ **Joint tolerance:**
+/- 2 mm

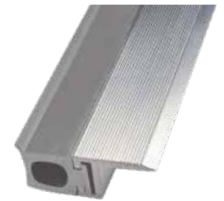

Load: Pedestrians, light rolling loads.

fuma // MOVE – SPORTS FLOOR PROFILES

Aluminum, with PVC infill **drilled**, as wall connection

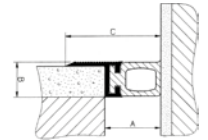

Length: 4.00 m

Item no.	Visible width in mm (C)
FSD 700/35E SG-400	60

→ **Joint width (A):**
30 - 35 mm

infill:
black

→ **Joint depth (B):**
min. 19 mm

→ **Joint tolerance:**
+/- 2 mm

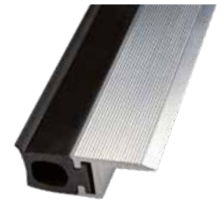

Length: 4.00 m

Item no.	Visible width in mm (C)
FSD 700/35E GG-400	60

→ **Joint width (A):**
30 - 35 mm

infill:
grey

→ **Joint depth (B):**
min. 19 mm

→ **Joint tolerance:**
+/- 2 mm

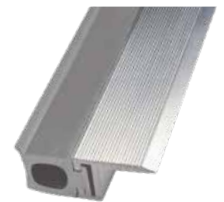

Load: Pedestrians, light rolling loads.

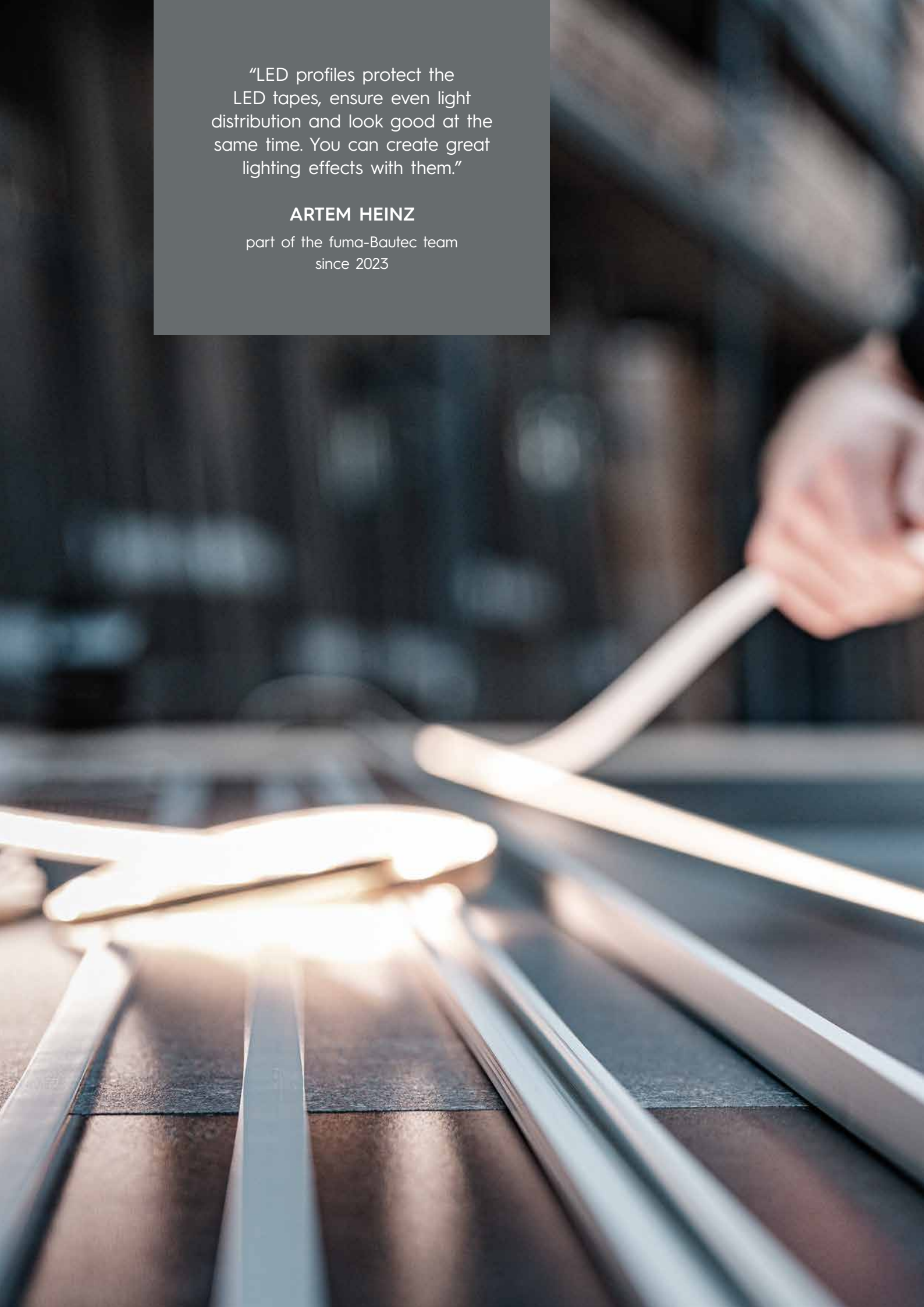

“LED profiles protect the LED tapes, ensure even light distribution and look good at the same time. You can create great lighting effects with them.”

ARTEM HEINZ

part of the fuma-Bautec team
since 2023

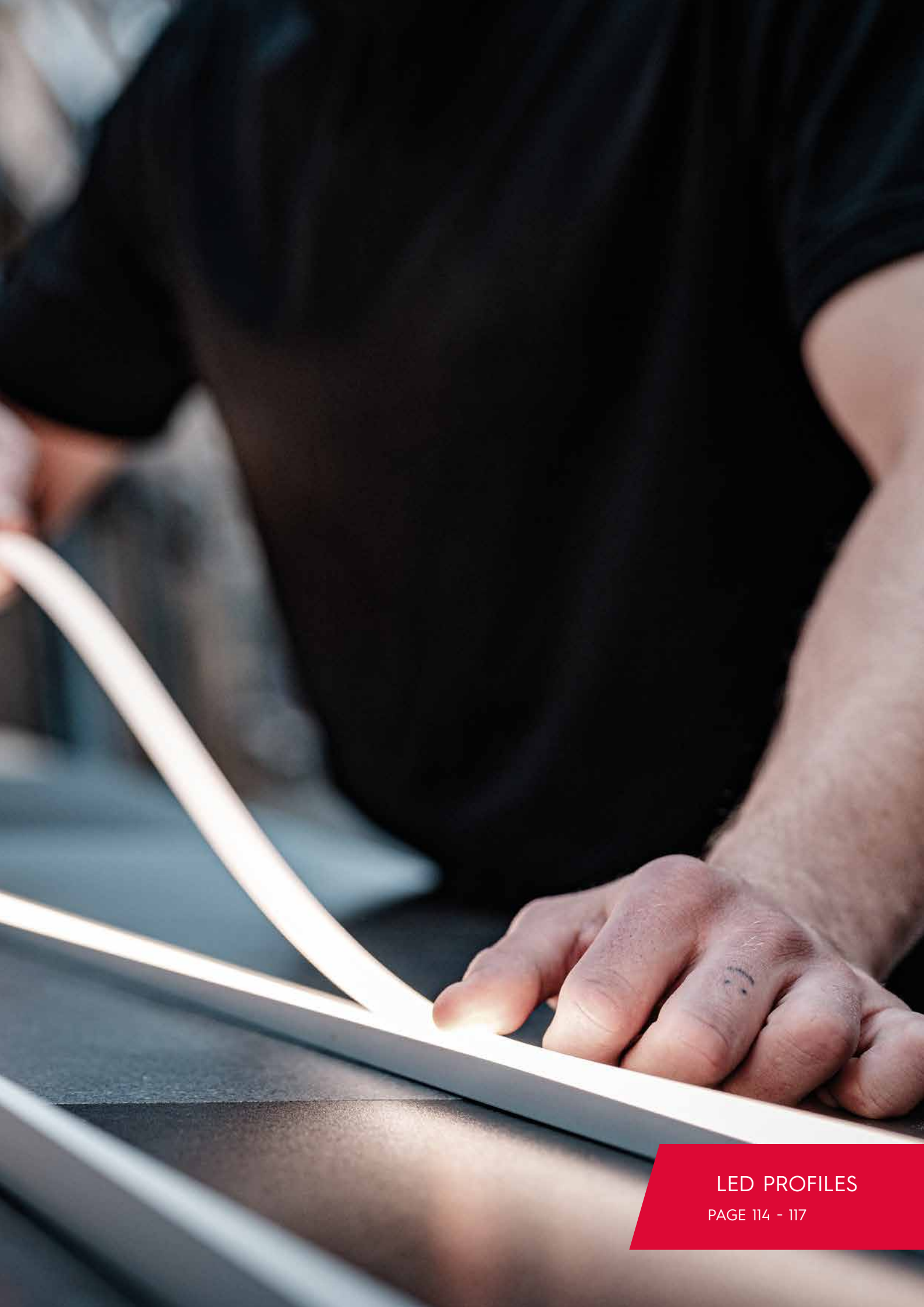

LED PROFILES

PAGE 114 - 117

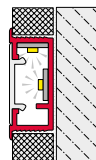

fuma // LIGHT - LED DECORATIVE PROFILES

Aluminum, for wall and floor* with edge cover

Length: 2.50 m

Height in mm	Width in mm	Item no.
9.0	24	LED-WF 240-09-250
12.5	24	LED-WF 240-12-250

Contents of delivery: Profile incl. white-translucent diffusing disc (without LED tape), holder for gluing in LED tape.

Maximum tape width: 12 mm.

***Attention:** Can only be used as a decorative profile in the floor area. Not walkable / loadable.



silver
anodized



fuma // LIGHT - LED DECORATIVE PROFILES

Aluminum, for wall and floor* without edge cover

Length: 2.50 m

Height in mm	Width in mm	Item no.
12.5	15	LED-W 150-12-250

Contents of delivery: Profile incl. white-translucent diffusing disc (without LED tape), holder for gluing in LED tape.

Maximum tape width: 12 mm.

***Attention:** Can only be used as a decorative profile in the floor area. Not walkable / loadable.



silver
anodized

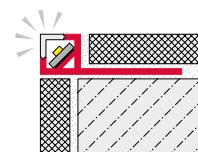

fuma // LIGHT - LED DECORATIVE PROFILES

Aluminum, for the wall area, angular with diffusing disc

Length: 2.50 m

Height in mm	Item no.
11.0	LED-FQAS 110-250

Contents of delivery: Profile incl. white-translucent diffusing disc (without LED tape), angular.

Maximum tape width: 12 mm.



silver
anodized

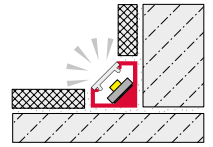

fuma // LIGHT - LED DECORATIVE PROFILES

Aluminum, for wall-internal corners with cover

Length: 2.50 m

Height in mm	Item no.
80	LED-IE-20-8

Contents of delivery: Profile incl. white-translucent diffusing disc (without LED tape).
Maximum tape width: 12 mm.

silver
anodized



fuma // LIGHT - LED SKIRTING PROFILES

Aluminum, with lighting upwards

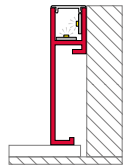

Length: 2.50 m

Height in mm	Width in mm	Item no.
60	16	LED-SL 6016-250

Contents of delivery: Profile incl. white-translucent diffusing disc (without LED tape).
Maximum tape width: 12 mm.

silver
anodized



Length: 2.50 m

Height in mm	Width in mm	Item no.
60	16	LED-SL 6016-BW-250

Contents of delivery: Profile incl. white-translucent diffusing disc (without LED tape).
Maximum tape width: 12 mm.

color coated
brilliant white



“We lay decoupling mats under tiles to prevent cracks. They serve to interrupt the mechanical connection between the tiling and the substrate. This absorbs tensions and movements.”

OLIVER SEIDEL

part of the fuma-Bautec team
since 2011





fuma-Bautec
www.fuma-bautec.com

fuma-Bautec
www.fuma-bautec.com

fuma-Bautec
www.fuma-bautec.com

flexi Original 1000m

Produkt mit PP-Netz	Produkt mit PP-Netz
Wasserdichte PP-Netze	Wasserdichte PP-Netze
Für die Verklebung von	Für die Verklebung von

Pc 1 30m2

Platon Flexi® Original

The original yellow decoupling mat



fuma // SEAL - WATERPROOFING MEMBRANE

with AbP test certificate

Item no.	Thickness in mm	Width in m	Length in m
FAB-B-050	0.5	1	30

1 pallet: 30 rolls of 30 sqm (900 sqm / pallet).

- made of a polyethylene film laminated on both sides with fleece
- indoor
- waterproof
- vapor retardant
- crack-bridging
- resistant to ageing and alkali
- non-rotting
- resistant to aqueous solutions of acids, alkalis and salts
- tested and approved by the german building authorities (AbP)

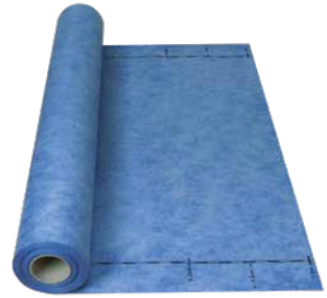

fuma // SEAL - SEALING TAPE

with AbP test certificate

SUITABLE FOR FAB

Item no.	Width in mm	Length in m
FDB 150-PP	120	50

Pieces / box: 6

- coated on both sides with polypropylene fleece
- elastic
- with protruding fleece backing
- high transverse elongation
- silicone-compatible
- meets the requirements of DIN 18534



fuma // SEAL - INTERNAL AND EXTERNAL CORNERS

with AbP test certificate

SUITABLE FOR FAB

Internal corner

Item no.
FDB 150-PP/I



Leg length: 120 mm
Pieces / box: 25

External corner

Item no.
FDB 150-PP/A



Leg length: 150 mm
Pieces / box: 25

fuma // SEAL - PIPE COLLAR FOR WALL AND FLOOR

with AbP test certificate

SUITABLE FOR FAB

Pipe collar wall

Item no.
FDB 150-PP/W



Dimension: 120 x 120 mm
Pieces / box: 25

Pipe collar floor

Item no.
FDB 150-PP/B



Dimension: 425 x 425 mm
Pieces / box: 25

fuma // SEAL – SEALING TAPE

DIN 18534

Item no.	Width in mm	Length in m
KDB 190/7050	120	50

Pieces / box: 6

- coated on both sides with polyester fleece
- elastic
- with protruding fleece backing
- high transverse elongation
- silicone-compatible
- **meets the requirements of DIN 18534**

**fuma // SEAL – INTERNAL AND EXTERNAL CORNERS**

DIN 18534

Internal corner

Item no.
KDB 190/I



Leg length: 140 mm
Pieces / box: 25

External corner

Item no.
KDB 190/A



Leg length: 140 mm
Pieces / box: 25

fuma // SEAL – PIPE COLLAR WITH EXPANSION ZONE LIP

DIN 18534

Item no.	Dimension in mm	Hole punching / expansion zone in mm
KDB 120/120-WAZ	120 x 120	12/41
KDB 150/150-WAZ	150 x 150	23/90
KDB 200/200-WAZ	200 x 200	55/140

Pieces / box 25 (KDB 120/120-WAZ, KDB 150/150-WAZ)
Pieces / box 10 (KDB 200/200-WAZ)

- **Carrier material:** Polypropylene fleece (on both sides)
- **membrane:** Polyurethane film
- tested and approved by the German building authorities (AbP)
- **meets the requirements of DIN 18534**

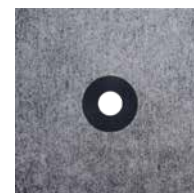
**fuma // SEAL – 3D CORNERS FOR SHOWER SLOPED PROFILES**

NBR rubber and PE fleece coating

SUITABLE FOR OUR SLOPE PROFILES FROM PAGE 130

Left

Item no.	Height in mm
FABE 3D-20L	20
FABE 3D-28L	28

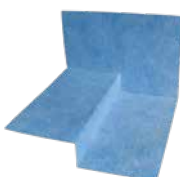

Leg length: 120 mm
Pieces / box: 10

Right

Item no.	Height in mm
FABE 3D-20R	20
FABE 3D-28R	28



Leg length: 120 mm
Pieces / box: 10

You will also find this article in the chapter Shower / Bathroom on page 132.

fuma // SEAL - CUT PROTECTION TAPE

DIN 18534, self-adhesive, for use in the areas of silicone joints

Item no.	Width in mm	Length in m
FSSB 50/SK10	50	10

Pieces / box: 1

- fabric made of **polyamide** and aramide with hotmelt pressure-sensitive adhesive and peel-off film

**fuma // SEAL - TUB SEALING TAPE**

DIN 18534, self-adhesive

Item no.	Width in mm	Length in m
KDB 2000/WAN	120	20.0
KDB 350/WAN	120	3.5

- **both-sided fleece-coated sealing tape equipped with a self-adhesive butyl strip**
- the protection strip made of smooth NBR rubber under butyl prevents the capillary effect
- optimal adaptation due to high elasticity
- simple and quick installation
- **Adhesive layer:** Butyl rubber strip (approx. 30 mm) with masking film
- **meets the requirements of DIN 18534**

**// OPTIONAL ACCESSORIES****Sound insulation strip**

Item no.	Width in mm	Length in m
FDB 350/SST	30	3.5

- **self-adhesive**
- thickness: 5 mm
- **meets the requirements of DIN 18534**

**fuma // SEAL - SEALING TAPE KDB/SK**

self-adhesive

Item no.	Width in mm	Length in m
KDB 100/SK	100	20
KDB 120/SK	120	20

Pieces / box: 4

- **self-adhesive fleece sealing tape**
- made of high-quality butyl rubber
- with laminated, tear-resistant fleece fabric
- extreme adhesion on almost all surfaces
- **eliminates the need for time-consuming insertion into the liquid seal and thus saves a complete work step and material**
- 2-part, removable protective film



fuma // SEAL - PRIMER

FB-Supergrund

Item no.	Packaging in kgs
FB-Supergrund 205	5
FB-Supergrund 210	10

Consumption: approx. 100 - 250 g/sqm

- solvent-free primer for absorbent / less absorbent substrates
- protects thin-bed mortar and levelling compounds from too rapid water removal
- prolongs the open time / improves the adhesion / prevents the formation of shrinkage cracks with coatings

**fuma // SEAL - ADHESIVE PRIMER**

FB-Superhaft

Item no.	Packaging in kgs
FB-Superhaft 105	5

Consumption: approx. 100 - 250 g/sqm

- solvent-free bonding agent for walls and floors (with optimised adhesion promoters)
- high bond strength on smooth and dense substrates
- creates a secured bonding of subsequent coatings and thin-bed mortars
- removal of the covering is reliably prevented

**fuma // SEAL - PROTECTIVE COATING**

FB-Superflex

Item no.	Packaging in kgs
FB-Superflex 010 blue	10
FB-Superflex 020 blue	20
FB-Superflex 010 grey	10
FB-Superflex 020 grey	20

Consumption: approx. 500 - 700 g/sqm per coat

- Solvent-free surface sealant based on styrene-butadiene
- ready for use, paintable, spatulable and rollable
- impermeable to water in the bonded state and silicone-compatible
- odourless and fast drying

**// OPTIONAL ACCESSORIES**

Pigment black

Item no.	Packaging in g
FB-Superflex Pigment	5

**// LIQUID SEALING**

Here you can see our products in application.

fuma // SEAL - SEALING AND DECOUPLING MEMBRANE

For indoor and outdoor areas

Item no.	Thickness in mm	Width in m	Length in m
FABVL-B 100	0.8	1	15

1 pallet: 30 rolls of 15 sqm (450 sqm/pallet).

- polyethylene film laminated with fleece on both sides
- indoor and outdoor
- vapor retardant
- crack-bridging
- resistant to ageing and alkali
- non-rotting
- resistant to aqueous solutions of acids, alkalis and salts



fuma // SEAL - SEALING TAPE

BACK IN OUR RANGE

SUITABLE FOR FABVL

For gluing in

Item no.	Width in mm	Length in m
FABV 050-B	120	50

Pieces / box: 4



fuma // SEAL - INTERNAL AND EXTERNAL CORNERS

BACK IN OUR RANGE

SUITABLE FOR FABVL

Internal corner

Item no.
FABI 050-B



Leg length: 120 mm
Pieces / box: 25

External corner

Item no.
FABA 050-B



Leg length: 120 mm
Pieces / box: 25

fuma // SEAL - DRAINAGE MAT

with mesh fabric

Item no.	Thickness in mm	Width in m	Length in m
FDT-K 080	8	1	12.5

1 pallet: 9 rolls of 12.5 sqm (112.5 sqm / pallet).

- polypropylene film with a knop structure
- very dimensionally stable and pressure-resistant
- with a laminated mesh fabric
- very high water drainage capacity
- rot-free / resistant to ageing

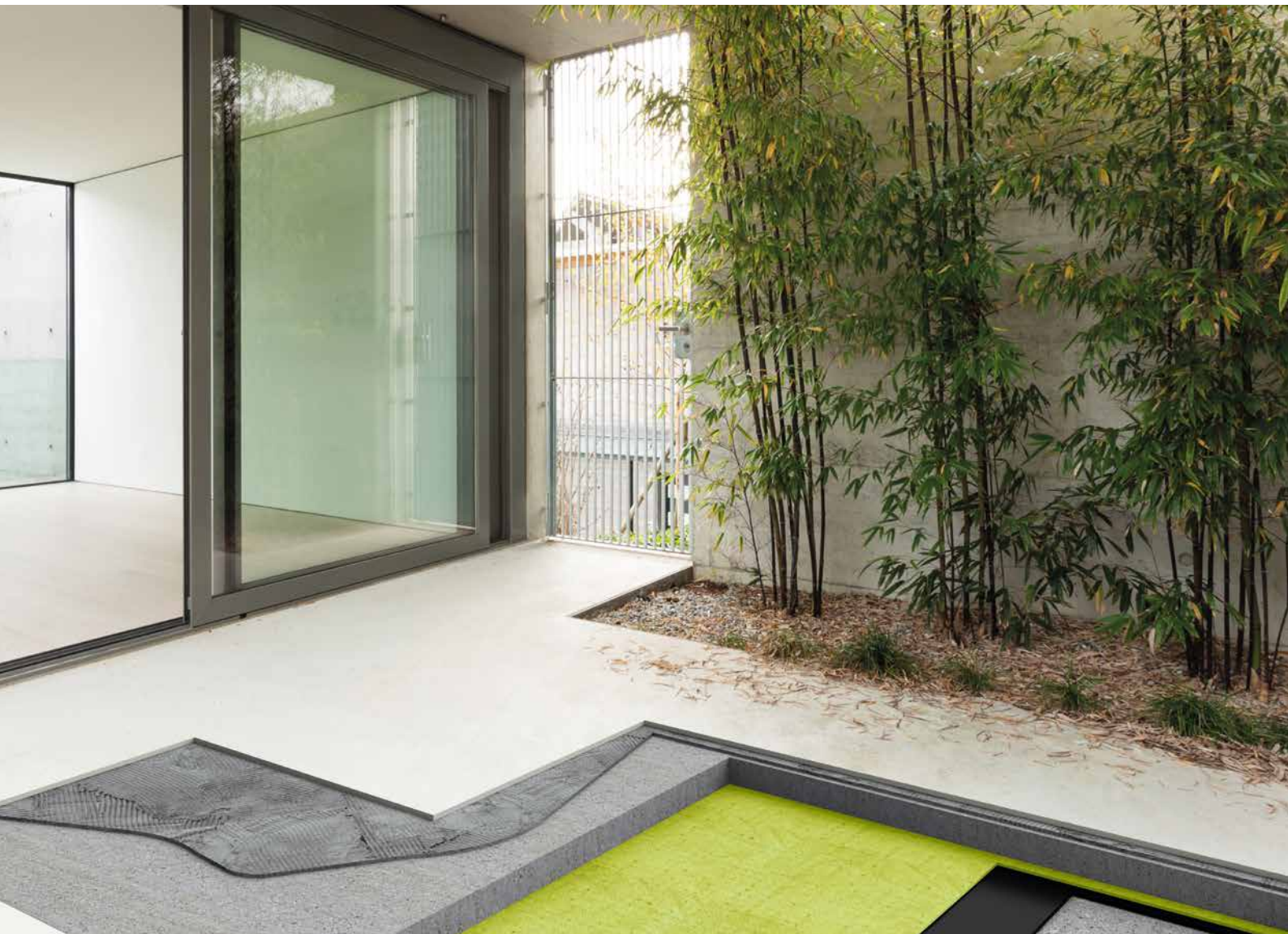

fuma // DEC - DECOUPLING MAT PLATON® FLEXI ORIGINAL
with mesh

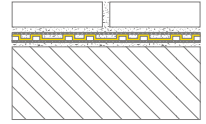

Item no.	Thickness in mm	Width in m	Length in m
Platon® Flexi Original	3	1	30

1 pallet: 6 rolls of 30 sqm (180 sqm / pallet).

- top side: polypropylene (pp) with a vulcanized grid
- back: backing fleece (pp)
- resistant to most chemicals



fuma // DEC - DECOUPLING MAT PLATON® FLEXI HEAT
Decoupling and accommodation of heating cables in one product

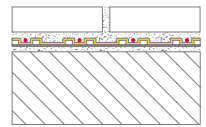

Item no.	Thickness in mm	Width in m	Length in m
Platon® Flexi Heat	7	1	15

1 pallet: 6 rolls of 15 sqm (90 sqm / pallet).

- top side: polypropylene (pp) with undercut stud design for easy installation of heating cables
- back: backing fleece (pp)
- suitable for heating cables 2-5 mm



// ABSORBS SHEAR FORCES FROM THE SUBSTRUCTURE

PLATON® FLEXI ORIGINAL / PLATON® FLEXI HEAT

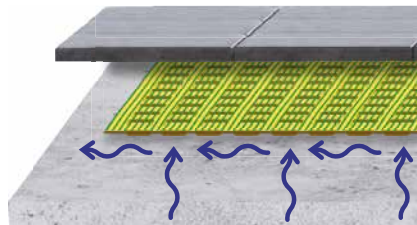
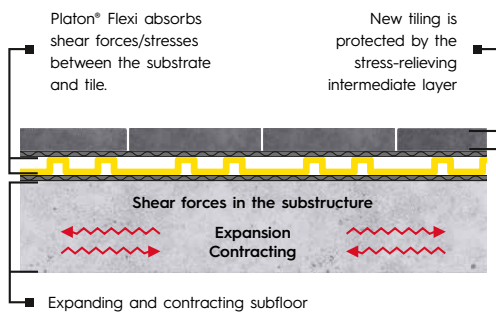

fuma // DEC - FIBREGLASS REINFORCEMENT AND DECOUPLING MAT

waterproof, alkali-resistant, frost-resistant

Item no.	Thickness in mm	Width in m	Length in m
FEK 100	1.5	1	25.0

1 pallet: 20 rolls of 25 sqm (500 sqm / pallet).

- **fibreglass fabric**
- underside glass fleece with high compressive and bending tensile strength
- warp: 3x 2 individual threads each

Use and advantages:

- for installation of large-format tiles
- for critical substrates (e.g. in the renovation of old buildings)
- glass fabric offers reliable protection from crack formation
- the surface roughness offers an optimal adhesion
- enormous functionality with a thickness of only 1.5 mm
- waterproof, alkali-resistant, frostproof

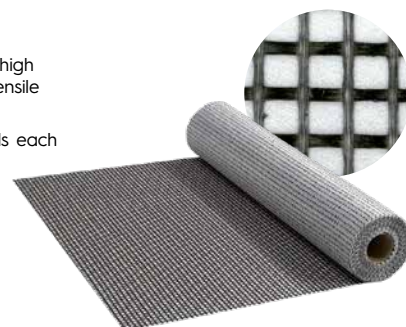
**fuma // DEC - THIN FILM DECOUPLING MAT**

Item no.	Thickness in mm	Width in m	Length in m
FDSE 180	0.8	1	50.0

1 pallet: 15 rolls of 50 sqm (750 sqm / pallet).

- **consisting of a specially mechanically post-treated fibre fleece compound for interior use**
- impact sound insulation value: 10 dB (based on ISO 10140)

**fuma // DEC - IMPACT SOUND INSULATION SILENCE FSR 17**polymer layer with special fleece on both sides, impact sound reduction: **17 db****BACK IN OUR RANGE**

Item no.	Thickness in mm	Width in m	Length in m
FSR 17	2.5	1	10.0

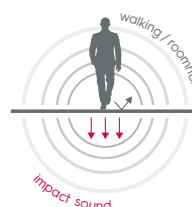
1 pallet: 24 rolls of 10 sqm (240 sqm / pallet).

“Our shower channels are not only functional, but also a real eye-catcher. They enable a level-access shower and are easy to clean.”

SASKIA NITSCHKE

part of the fuma-Bautec team
since 2019





SHOWER / BATHROOM

PAGE 128 - 149

fuma // DRAIN - WALL SLOPE PROFILES

Stainless steel 1.4301/304, for floor-level shower facilities, 2% slope

Profile left

Length in cm	Item no.	Height (H1) in mm	Height (H2) in mm
98.0	FWA-098-08/LI	8.0	24.0
98.0	FWA-098-10/LI	10.0	24.0
98.0	FWA-098-11/LI	11.0	24.0
148.0	FWA-148-08/LI	8.0	32.0
148.0	FWA-148-10/LI	10.0	32.0
148.0	FWA-148-11/LI	11.0	32.0
200.0	FWA-200-08/LI	8.0	40.0
200.0	FWA-200-10/LI	10.0	40.0
200.0	FWA-200-11/LI	11.0	40.0

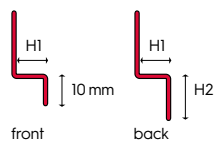

left version
(view to drainage channel)



Profile left

Length in cm	Item no.	Height (H1) in mm	Height (H2) in mm
98.0	FWA-098-10/LI-SW	10.0	24.0
98.0	FWA-098-11/LI-SW	11.0	24.0
148.0	FWA-148-10/LI-SW	10.0	32.0
148.0	FWA-148-11/LI-SW	11.0	32.0

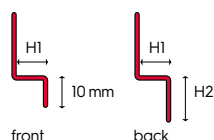

left version
(view to drainage channel)



Profile right

Length in cm	Item no.	Height (H1) in mm	Height (H2) in mm
98.0	FWA-098-08/RE	8.0	24.0
98.0	FWA-098-10/RE	10.0	24.0
98.0	FWA-098-11/RE	11.0	24.0
148.0	FWA-148-08/RE	8.0	32.0
148.0	FWA-148-10/RE	10.0	32.0
148.0	FWA-148-11/RE	11.0	32.0
200.0	FWA-200-08/RE	8.0	40.0
200.0	FWA-200-10/RE	10.0	40.0
200.0	FWA-200-11/RE	11.0	40.0

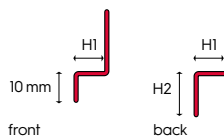

right version
(view to drainage channel)



Profile right

Length in cm	Item no.	Height (H1) in mm	Height (H2) in mm
98.0	FWA-098-10/RE-SW	10.0	24.0
98.0	FWA-098-11/RE-SW	11.0	24.0
148.0	FWA-148-10/RE-SW	10.0	32.0
148.0	FWA-148-11/RE-SW	11.0	32.0

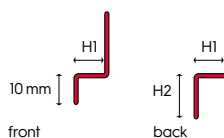

right version
(view to drainage channel)



fuma // DRAIN – FLOOR SLOPE PROFILES

Stainless steel 1.4301/304, for floor-level shower facilities, 2% slope

Profile left

Length in cm	Item no.	Height (H1) in mm	Height (H2) in mm
98.0	FBO-098-08/LI	8.0	24.0
98.0	FBO-098-10/LI	10.0	24.0
98.0	FBO-098-11/LI	11.0	24.0
148.0	FBO-148-08/LI	8.0	32.0
148.0	FBO-148-10/LI	10.0	32.0
148.0	FBO-148-11/LI	11.0	32.0
200.0	FBO-200-10/LI	10.0	40.0
200.0	FBO-200-11/LI	11.0	40.0



brushed



left version
(view to drainage channel)

Profile left

Length in cm	Item no.	Height (H1) in mm	Height (H2) in mm
98.0	FBO-098-10/LI-SW	10.0	24.0
98.0	FBO-098-11/LI-SW	11.0	24.0
148.0	FBO-148-10/LI-SW	10.0	32.0
148.0	FBO-148-11/LI-SW	11.0	32.0
200.0	FBO-200-10/LI-SW	10.0	40.0
200.0	FBO-200-11/LI-SW	11.0	40.0



color coated
black matt
RAL 9005



left version
(view to drainage channel)

Profile right

Length in cm	Item no.	Height (H1) in mm	Height (H2) in mm
98.0	FBO-098-08/RE	8.0	24.0
98.0	FBO-098-10/RE	10.0	24.0
98.0	FBO-098-11/RE	11.0	24.0
148.0	FBO-148-08/RE	8.0	32.0
148.0	FBO-148-10/RE	10.0	32.0
148.0	FBO-148-11/RE	11.0	32.0
200.0	FBO-200-10/RE	10.0	40.0
200.0	FBO-200-11/RE	11.0	40.0

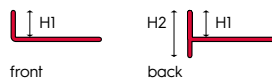

brushed



right version
(view to drainage channel)

Profile right

Length in cm	Item no.	Height (H1) in mm	Height (H2) in mm
98.0	FBO-098-10/RE-SW	10.0	24.0
98.0	FBO-098-11/RE-SW	11.0	24.0
148.0	FBO-148-10/RE-SW	10.0	32.0
148.0	FBO-148-11/RE-SW	11.0	32.0
200.0	FBO-200-10/RE-SW	10.0	40.0
200.0	FBO-200-11/RE-SW	11.0	40.0

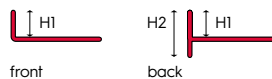

color coated
black matt
RAL 9005



right version
(view to drainage channel)

fuma // DRAIN – FLOOR SLOPE PROFILES

Stainless steel 1.4301 / 304, for glass partitions, 2 % slope

Profile left

Length in cm	Item no.	Height (H1) in mm	Height (H2) in mm
100.0	FGLAS-100-11/LI	11.0	25.0
120.0	FGLAS-120-11/LI	11.0	28.0
150.0	FGLAS-150-11/LI	11.0	33.0
200.0	FGLAS-200-11/LI	11.0	40.0



brushed



left version
(view to drainage channel)
internal dimension: 13 mm

Profile left

Length in cm	Item no.	Height (H1) in mm	Height (H2) in mm
100.0	FGLAS-100-11/LI-SW	11.0	25.0
120.0	FGLAS-120-11/LI-SW	11.0	28.0
150.0	FGLAS-150-11/LI-SW	11.0	33.0
200.0	FGLAS-200-11/LI-SW	11.0	40.0



color coated
black matt
RAL 9005



left version
(view to drainage channel)
internal dimension: 13 mm

Profile right

Length in cm	Item no.	Height (H1) in mm	Height (H2) in mm
100.0	FGLAS-100-11/RE	11.0	25.0
120.0	FGLAS-120-11/RE	11.0	28.0
150.0	FGLAS-150-11/RE	11.0	33.0
200.0	FGLAS-200-11/RE	11.0	40.0

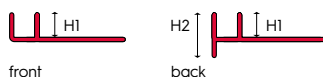

brushed



right version
(view to drainage channel)
internal dimension: 13 mm

Profile right

Length in cm	Item no.	Height (H1) in mm	Height (H2) in mm
100.0	FGLAS-100-11/RE-SW	11.0	25.0
120.0	FGLAS-120-11/RE-SW	11.0	28.0
150.0	FGLAS-150-11/RE-SW	11.0	33.0
200.0	FGLAS-200-11/RE-SW	11.0	40.0

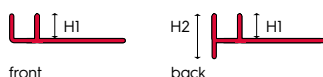

color coated
black matt
RAL 9005



right version
(view to drainage channel)
internal dimension: 13 mm

fuma // DRAIN – 3D CORNERS FOR SHOWER SLOPED PROFILES

NBR rubber and PE fleece coating

SUITABLE FOR OUR SLOPE PROFILES

Left

Item no.	Height in mm
FABE 3D-20L	20
FABE 3D-28L	28

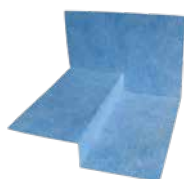

Right

Item no.	Height in mm
FABE 3D-20R	20
FABE 3D-28R	28



Leg length: 120 mm

Leg length: 120 mm

You will also find this article in the chapter Sealing / Decoupling on page 121.

fuma // DRAIN - WEDGE PROFILES

Stainless steel 1.4301/304, for floor-level shower facilities, 2% slope

Profile left

Length in cm	Item no.	Height (H1) in mm	Height (H2) in mm
98.0	FK2-098/LI	8.00	28.0
148.0	FK2-148/LI	8.00	38.0
198.0	FK2-198/LI	8.00	48.0

The 40 mm wide support leg is built into the slope area/shower area.



left version



Profile right

Length in cm	Item no.	Height (H1) in mm	Height (H2) in mm
98.0	FK2-098/RE	8.00	28.0
148.0	FK2-148/RE	8.00	38.0
198.0	FK2-198/RE	8.00	48.0

The 40 mm wide support leg is built into the slope area/shower area.



right version



fuma // DRAIN - U-PROFILES

Stainless steel 1.4301/304, for glass partitions for the floor / wall area - without slope



Internal dimension: 11 mm

Length in cm	Item no.
220.0	FU-S 1411

Internal dimension: 11 mm

Length in cm	Item no.
220.0	FU-B 1411

Internal dimension: 11 mm

Length in cm	Item no.
220.0	FU-C 1411-SW

Internal dimension: 13 mm

Length in cm	Item no.
220.0	FU-S 1413

Internal dimension: 13 mm

Length in cm	Item no.
220.0	FU-B 1413

Internal dimension: 13 mm

Length in cm	Item no.
220.0	FU-C 1413-SW

internal dimension 11 mm:
unwinding (external dimensions):
14 x 14 x 14 mm

internal dimension 13 mm:
unwinding (external dimensions):
14 x 16 x 14 mm

thickness: 1.5 mm



fuma // DRAIN - U-PROFILES

Stainless steel 1.4301/304, for glass partitions (up to 12 mm) for the floor / wall area - without slope

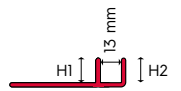

Internal dimension: 13 mm

Length in cm	Item no.	Height (H1) in mm	Height (H2) in mm
220.0	FGLAS-220-20	20.0	20.0

brushed



Internal dimension: 13 mm

Length in cm	Item no.	Height (H1) in mm	Height (H2) in mm
220.0	FGLAS-220-20-SW	20.0	20.0

color coated
black matt
RAL 9005

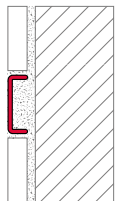
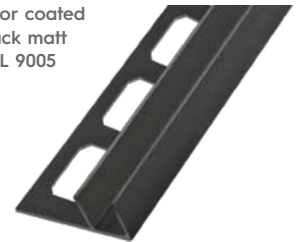

fuma // DRAIN - DECORATIVE WALL PROFILES

Stainless steel 1.4301/304, for a clear connection to FWA and FBO profiles - without slope

Width: 24 mm

Length in cm	Item no.
125.0	FDES 240-125

Width: 32 mm

Length in cm	Item no.
125.0	FDES 320-125

Width: 40 mm

Length in cm	Item no.
125.0	FDES 400-125

brushed



Width: 24 mm

Length in cm	Item no.
125.0	FDEC 240-125-SW

Width: 32 mm

Length in cm	Item no.
125.0	FDEC 320-125-SW

Width: 40 mm

Length in cm	Item no.
125.0	FDEC 400-125-SW

color coated
black matt
RAL 9005





fuma // DRAIN - SHOWER CHANNEL FD-LINE COMPLETE SET
Stainless steel brushed

Length in mm	Item no.
600	FD-LINE-FM-600
700	FD-LINE-FM-700
800	FD-LINE-FM-800
900	FD-LINE-FM-900
1000	FD-LINE-FM-1000
1200	FD-LINE-FM-1200



// DESCRIPTION

- complete set ready for installation up to visual dimension 1,200 mm
 - height-adjustable channel body
 - grating for use as tile trough or closed stainless steel
 - cover with brushed finish
 - installation dimensions: 120 mm x 70 mm
 - channel width: 77 mm
 - siphon: ABS, high impact resistant
 - sealing: pre-assembled
 - tile thickness: 6 - 18 mm
 - drain DN 40 / seal water level: 28 mm
- Perfect for renovations with low installation height

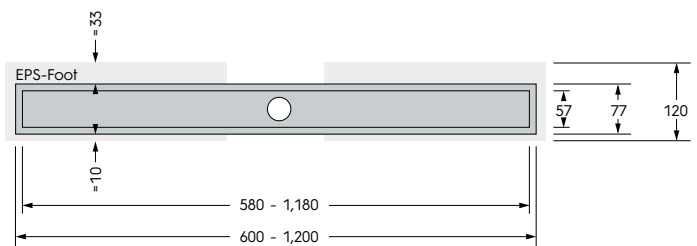

// INSTALLATION OPTIONS



// DRAINAGE PERFORMANCE

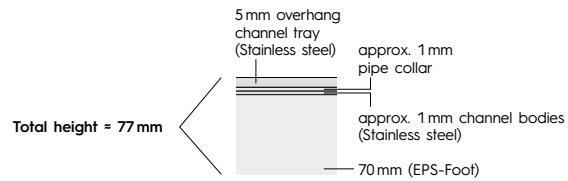

fuma // DRAIN - DRAINSET DN 50 HORIZONTAL
incl. mounting accessories

Item no.
FD-LINE-FM-DN50-horizontal

// DESCRIPTION

Set consisting of drain DN 50 and 2 EPS elevations to compensate for the higher construction, incl. motage accessories.

// DRAINAGE PERFORMANCE

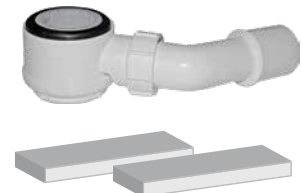

fuma // DRAIN - DRAIN DN 50 VERTICAL
incl. mounting accessories

Item no.
FD-LINE-FM-DN50-vertical

// DRAINAGE PERFORMANCE



fuma // DRAIN – SHOWER CHANNEL EASY DRAIN BASIC STEPS

Stainless steel brushed

Discontinued item

Length in mm	Item no.
500	BD-50-Steps
600	BD-60-Steps
700	BD-70-Steps
800	BD-80-Steps
900	BD-90-Steps
1000	BD-100-Steps
1200	BD-120-Steps

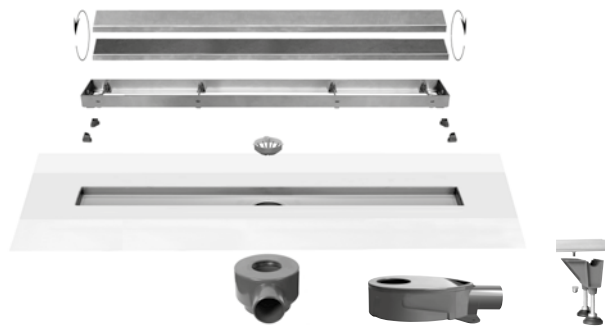

// DESCRIPTION

- channel width: 68 mm
- installation depth with siphon: from 68 mm
- siphon: ABS, high impact resistant
- sealing: pre-assembled
- tile thickness: 7 - 18 mm
- drain DN 40 / seal water level: 28 mm
- drain DN 50 / seal water level: 50 mm

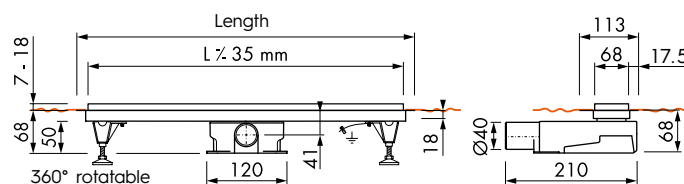

// INSTALLATION OPTIONS



// DRAINAGE PERFORMANCE



10 YEARS WARRANTY

WPS technology - pre-assembled sealing fleece

fuma // DRAIN – EASY DRAIN DN 50 VERTICAL

suitable for shower channel Easy drain basic steps

Discontinued item

Item no.
EDM2-O

// DESCRIPTION

- siphon: ABS, high impact resistant
- drain DN 50

// DRAINAGE PERFORMANCE

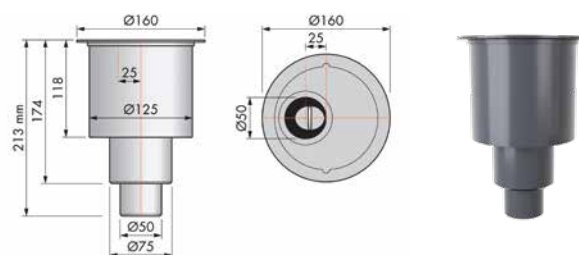

10 YEARS WARRANTY

WPS technology - pre-assembled sealing fleece

fuma // DRAIN - SHOWER CHANNEL EASY DRAIN FR-LINE
Stainless steel brushed

Length in mm	Item no.
700	FR-LINE-700-S
800	FR-LINE-800-S
900	FR-LINE-900-S
1000	FR-LINE-1000-S
1200	FR-LINE-1200-S



fuma // DRAIN - SHOWER CHANNEL EASY DRAIN FR-LINE
Stainless steel polished

Length in mm	Item no.
700	FR-LINE-700-P
800	FR-LINE-800-P
900	FR-LINE-900-P
1000	FR-LINE-1000-P
1200	FR-LINE-1200-P

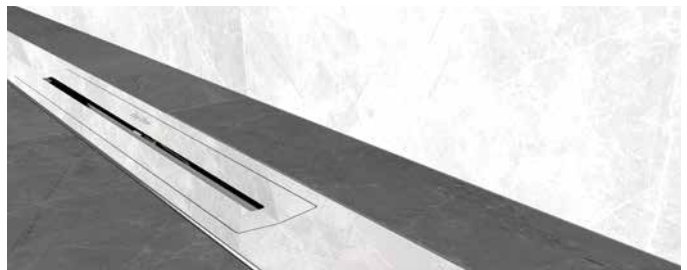

COMMON INFO FOR EASY DRAIN FR-LINE

// DESCRIPTION

- **channel width:** 50 mm
- **seal water level:** 28 and 50 mm
- **drainage performance:**
DN 40: 28 l/min (28 mm)
DN 50: 33 l/min (50 mm)
- **installation depth with siphon:** from 69 / 85 mm
- **siphon:** rotatable, adjustable
- **connection:** horizontal
- **sealing:** pre-assembled
- **tile thickness:** 7 - 18 mm

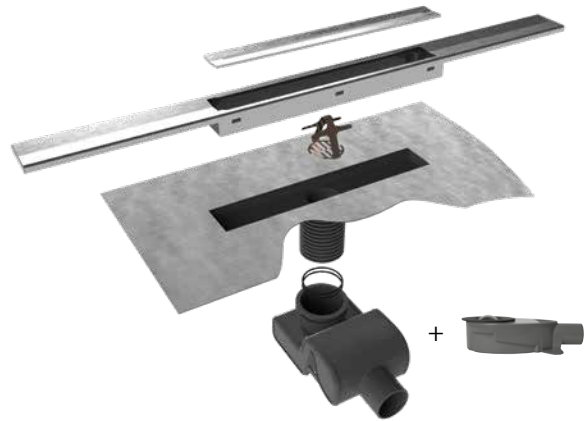

// SEAL WATER LEVEL 28 MM

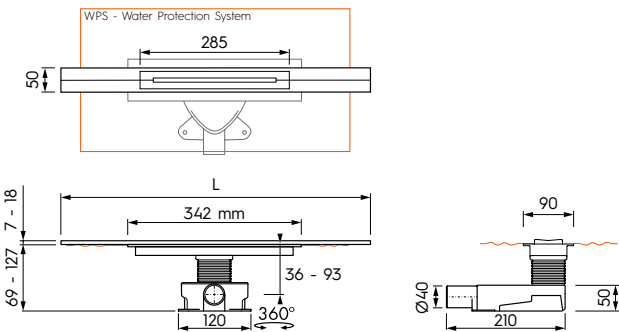

// SEAL WATER LEVEL 50 MM

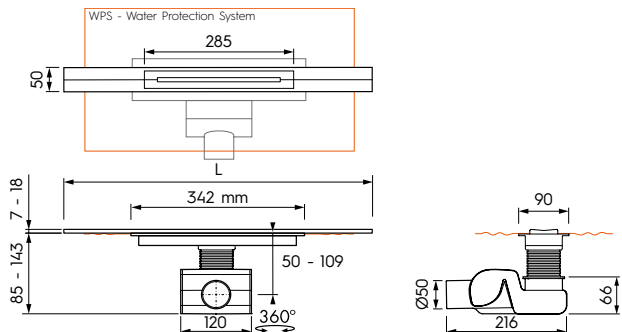

// INSTALLATION OPTIONS



// DRAINAGE PERFORMANCE

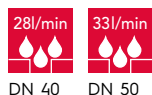

10 YEARS WARRANTY

WPS technology - pre-assembled sealing fleece

fuma // DRAIN – SHOWER CHANNEL EASY DRAIN FR-LINE WALL

Stainless steel brushed

Length in mm	Item no.
700	FR-LINE-700-SW
800	FR-LINE-800-SW
900	FR-LINE-900-SW
1000	FR-LINE-1000-SW
1200	FR-LINE-1200-SW



fuma // DRAIN – SHOWER CHANNEL EASY DRAIN FR-LINE

Stainless steel polished

Length in mm	Item no.
700	FR-LINE-700-PW
800	FR-LINE-800-PW
900	FR-LINE-900-PW
1000	FR-LINE-1000-PW
1200	FR-LINE-1200-PW



COMMON INFO FOR EASY DRAIN FR-LINE WALL

// DESCRIPTION

- **channel width:**
50 mm
- **seal water level:**
28 and 50 mm
- **drainage performance:**
DN 40: 28 l/min (28 mm)
DN 50: 33 l/min (50 mm)
- **installation depth with siphon:**
from 69 / 85 mm
- **siphon:**
rotatable, adjustable
- **connection:**
horizontal
- **sealing:**
pre-assembled
- **tile thickness:**
7 - 18 mm

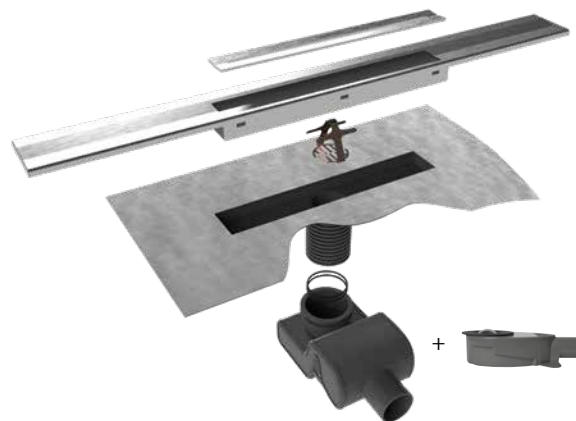

// SEAL WATER LEVEL 28 MM

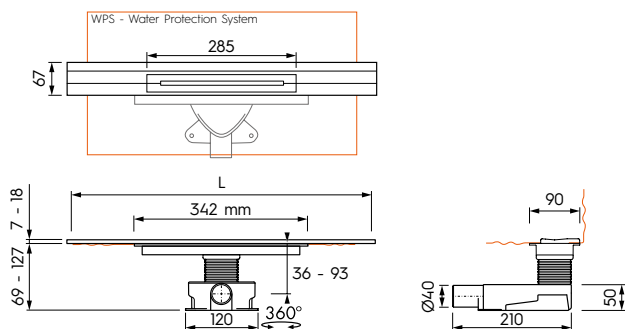

// SEAL WATER LEVEL 50 MM

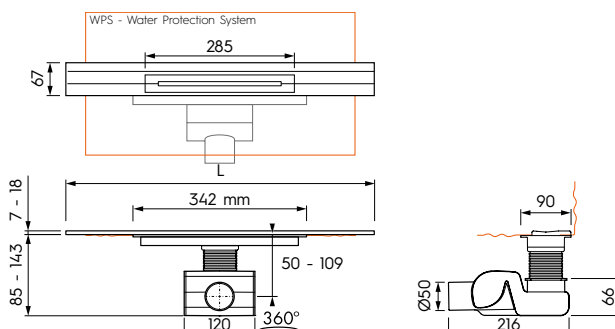

// INSTALLATION OPTIONS



// DRAINAGE PERFORMANCE

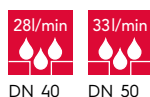

10 YEARS WARRANTY

WPS technology - pre-assembled sealing fleece

fuma // DRAIN - DRAINSET FD-VARIO
with sealing system incl. **stainless steel cover**

Dimension in cm	Item no.
10 x 10	FD-Vario 100/40
15 x 15	FD-Vario 150/40

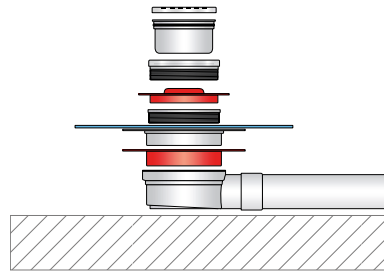

// DESCRIPTION

- floor drain and sealing system incl. cover
- incl. Drainage and grate
- seal water level: 25 mm
- installation height: 53 mm
- height adjustable: 7 - 17 mm
- drain: horizontal
- outlet drain pipe: DN 40
- drainage performance: in accordance with DIN EN 1253

fuma // DRAIN - DRAINSET AQUA DRAIN
incl. **stainless steel cover**

Dimension in cm	Item no.
10 x 10	AquaW-10x10-MSI6
15 x 15	AquaW-15x15-MSI6



10 YEARS WARRANTY

WPS technology - pre-assembled sealing fleece

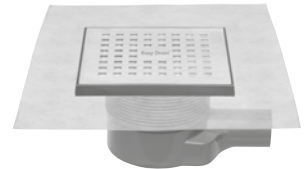

// DESCRIPTION

- complete set incl. cover
- tile thickness: 8 - 18 mm
- connection: horizontal
- drain DN 40 / seal water level variable: 50 - 25 mm

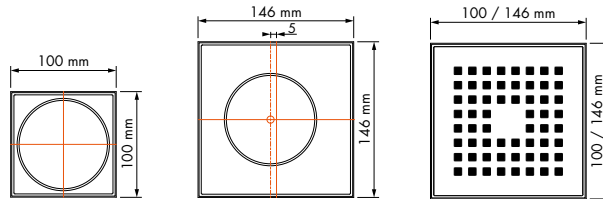

fuma // DRAIN – DRAINSET AQUA DRAIN

incl. **tileable cover**

Dimension in cm	Item no.
10 x 10	AquaW-10x10-MSI6-T
15 x 15	AquaW-15x15-MSI6-T



10 YEARS WARRANTY

WPS technology - pre-assembled sealing fleece

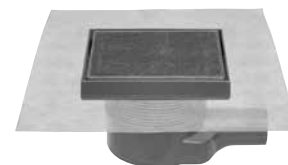

// DESCRIPTION

- complete set incl. cover
- tile thickness: 8 - 18 mm
- connection: horizontal
- drain DN 40 / seal water level variable: 50 - 25 mm

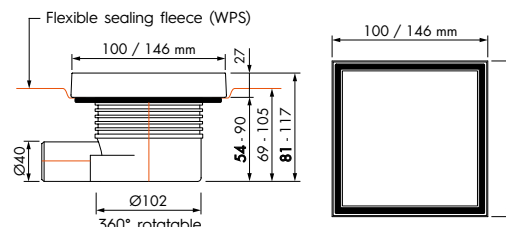

fuma // DRAIN – MULTI SIPHON HOUSING

horizontal **direction**, exit 50 mm

Item no.
EDMSI



10 YEARS WARRANTY

WPS technology - pre-assembled sealing fleece



// DESCRIPTION

- drain DN 50 / seal water level: 30 mm
- drain DN 50 / seal water level: 35 mm
- drain DN 50 / seal water level: 50 mm

// DRAINAGE PERFORMANCE

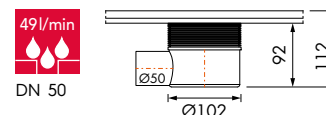
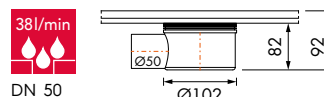
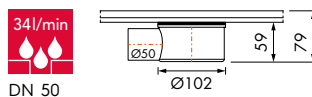

fuma // DRAIN – MULTI SIPHON HOUSING

vertical **direction**, exit 50 mm

Item no.
EDMSI 3



10 YEARS WARRANTY

WPS technology - pre-assembled sealing fleece



// DESCRIPTION

- drain DN 50 / seal water level: 35 mm
- drain DN 50 / seal water level: 50 mm
- drain DN 50 / seal water level: 70 mm

// DRAINAGE PERFORMANCE

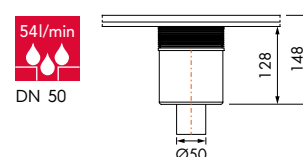
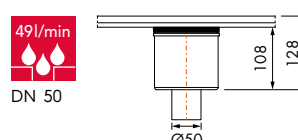
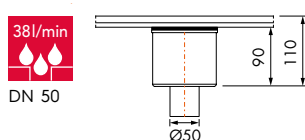

fuma // DRAIN - SHOWER BOARD F-BED

drain central / decentral / horizontal / vertical

drain central horizontal

A x B x Height in mm	Item no.	C1/C2 Center of drain from edge in mm	Installation height in mm
900 x 900 x 45	F-BED 90/90ZW	450/450	120
1000 x 1000 x 50	F-BED 100/100ZW	500/500	120
1200 x 900 x 50	F-BED 120/90ZW	600/450	120
1200 x 1200 x 50	F-BED 120/120ZW	600/600	120
1500 x 900 x 50	F-BED 150/90ZW	750/450	125
1500 x 1500 x 50	F-BED 150/150ZW	750/750	125
1800 x 900 x 50	F-BED 180/90ZW	900/450	120

→ drain **central, horizontal**, DN 50, 42 l/min.

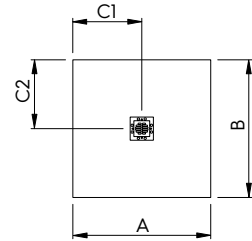

drain decentral horizontal

A x B x Height in mm	Item no.	C1/C2 Center of drain from edge in mm	Installation height in mm
900 x 900 x 45	F-BED 90/90DW	250/250	115
1000 x 1000 x 50	F-BED 100/100DW	250/250	120
1200 x 1200 x 50	F-BED 120/120DW	250/250	120

→ drain **decentral, horizontal**, DN 50, 42 l/min.

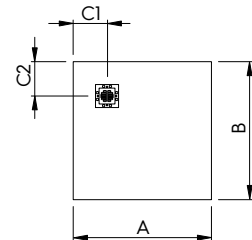

drain central vertical

A x B x Height in mm	Item no.	C1/C2 Center of drain from edge in mm	Installation height in mm
900 x 900 x 45	F-BED 90/90ZS	450/450	45
1000 x 1000 x 50	F-BED 100/100ZS	500/500	50
1200 x 900 x 50	F-BED 120/90ZS	600/450	50
1200 x 1200 x 50	F-BED 120/120ZS	600/600	50
1500 x 900 x 50	F-BED 150/90ZS	750/450	50
1500 x 1500 x 50	F-BED 150/150ZS	750/750	50
1800 x 900 x 50	F-BED 180/90ZS	900/450	50

→ drain **central, vertical**, DN 50, 60 l/min.

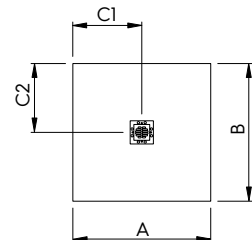

drain decentral vertical

A x B x Height in mm	Item no.	C1/C2 Center of drain from edge in mm	Installation height in mm
900 x 900 x 45	F-BED 90/90DS	250/250	45
1000 x 1000 x 50	F-BED 100/100DS	250/250	45
1200 x 1200 x 50	F-BED 120/120DS	250/250	50

→ drain **decentral, vertical**, DN 50, 60 l/min.

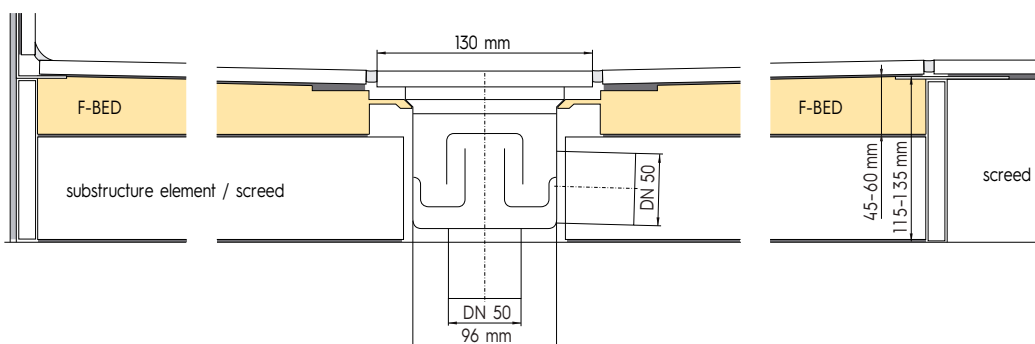
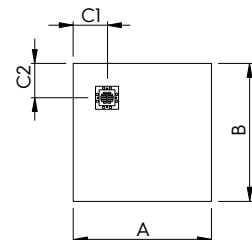

// DESCRIPTION

- waterproof, coated, tileable hard foam shower system, with integrated slope of approx. 2.5%, centred or decentrally installed and sealed drain plate, with vertical or horizontal drain
- as substrate in accordance with DIN 18534-1 fully coated on site with liquid sealing material in accordance with DIN 18534-3; up to water impact class W3-I
- **drainage capacity horizontal drain:** 42 l/min.
- **drainage capacity vertical drain:** 60 l/min.
- **standard-compliant DN 50 connection, seal water level 50 mm** according to DIN EN 274
- considering geometry and installation height, the shower system can be shortened all around by the installer
- by using tiles with a minimum size of 100 x 100 mm, sufficient stability is achieved for use with wheelchairs
- by using tiles with a minimum size of 50 x 50 mm, sufficient stability for use with wheelchairs is achieved by additionally incorporating a fibreglass fabric in the tile adhesive bed
- various special sizes on request

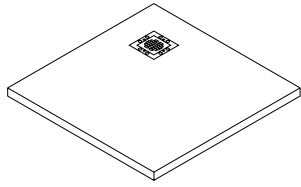
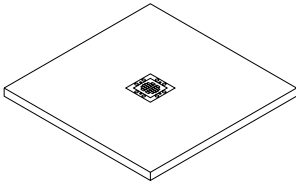

fuma // WALL - SHOWER SHELVES

Stainless steel 1.4301 / 304, tileable, rectangular narrow / wide

Depth: 115 mm

Width x depth in mm	Item no.
300 x 115	FB-RA 300S
400 x 115	FB-RA 400S

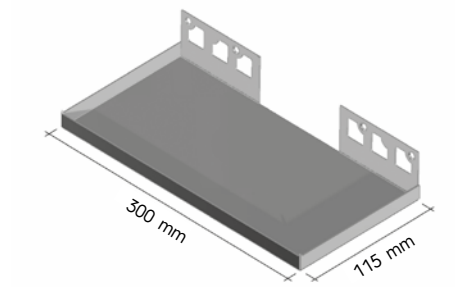

Depth: 150 mm

Width x depth in mm	Item no.
300 x 150	FB-RA 300B
400 x 150	FB-RA 400B

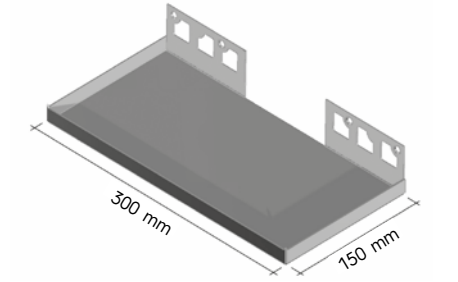

fuma // WALL - SHOWER SHELVES

Stainless steel 1.4301 / 304, tileable, triangular, isosceles

Width in mm	Leg length in mm	Item no.
240	170	FB-EA 170
275	195	FB-EA 195
310	220	FB-EA 220
345	245	FB-EA 245
380	270	FB-EA 270

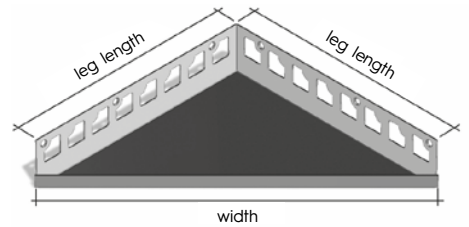

fuma // WALL - SHOWER SHELVES

Stainless steel 1.4301 / 304, tileable, trapezoidal, non isosceles

Short side left

Item no.
FB-EA 440L

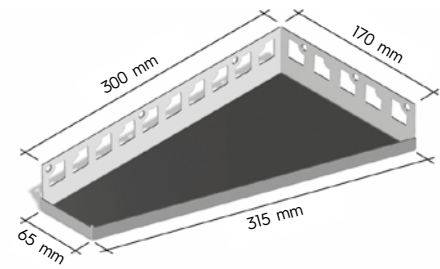
**Short side right**

Item no.
FB-EA 430R

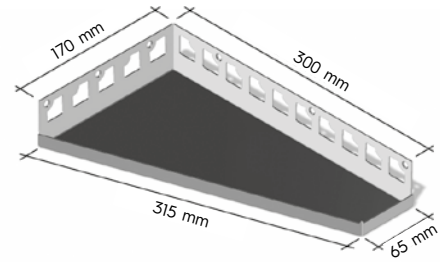
**fuma // WALL - SHOWER SHELVES**

Stainless steel 1.4301 / 304, tileable, diamond-shaped

Item no.
FB-EA 200T

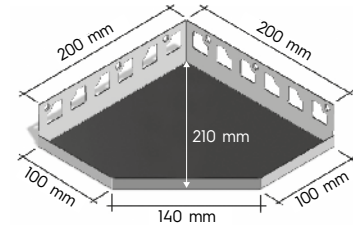

fuma // WALL - SHOWER SHELVES

Stainless steel 1.4301/304, triangular, isosceles, line design - retrofitting possible, material thickness: 1.5 mm

brushed

Width in mm	Leg length in mm	Item no.
280	200	FB-Line 280-S

brushed

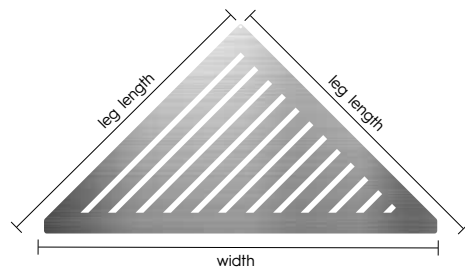

white matt RAL 9003

Width in mm	Leg length in mm	Item no.
280	200	FB-Line 280-BW

white matt RAL 9003

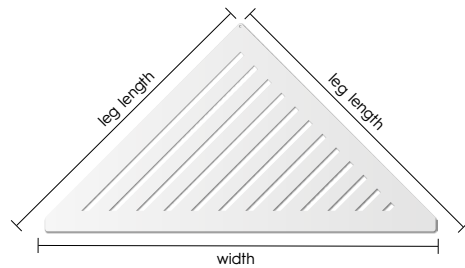

black matt RAL 9005

Width in mm	Leg length in mm	Item no.
280	200	FB-Line 280-SW

black matt RAL 9005

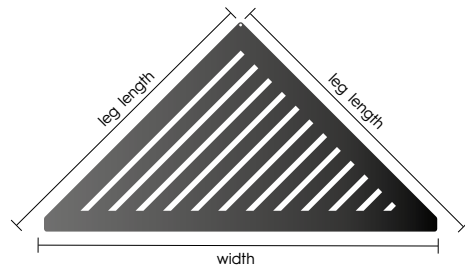

fuma // WALL - SHOWER SHELVES

Stainless steel 1.4301/304, diamond-shaped, line design - retrofitting possible, material thickness: 1.5 mm

brushed

Item no.
FB-Line 145-S

brushed

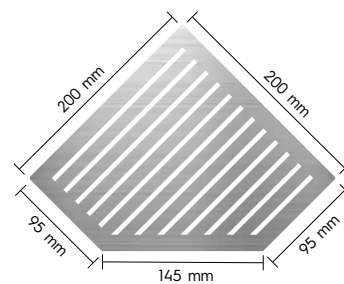

white matt RAL 9003

Item no.
FB-Line 145-BW

white matt RAL 9003

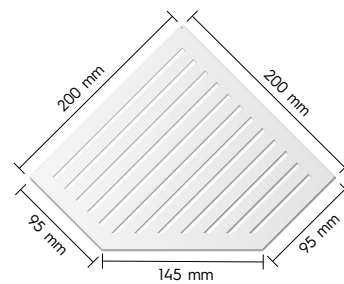

black matt RAL 9005

Item no.
FB-Line 145-SW

black matt RAL 9005

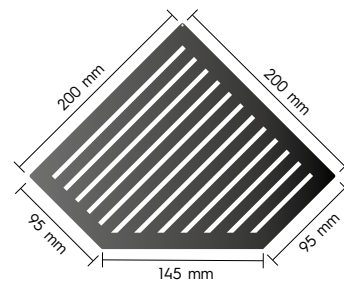

fuma // WALL - SHOWER SHELVES

Stainless steel 1.4301/304, triangular, isosceles, wave design - retrofitting possible, material thickness: 1.5 mm

brushed

Width in mm	Leg length in mm	Item no.
280	200	FB-Wave 280-S

brushed

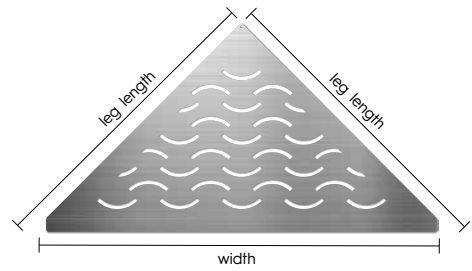

white matt RAL 9003

Width in mm	Leg length in mm	Item no.
280	200	FB-Wave 280-BW

white matt RAL 9003

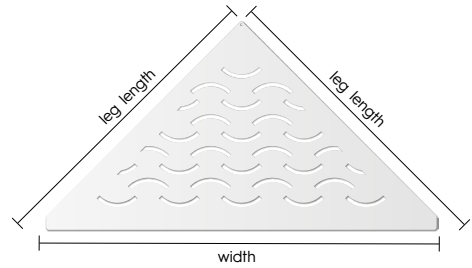

black matt RAL 9005

Width in mm	Leg length in mm	Item no.
280	200	FB-Wave 280-SW

black matt RAL 9005

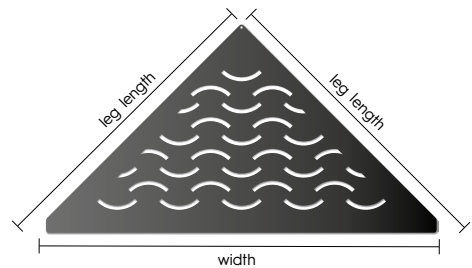

fuma // WALL - SHOWER SHELVES

Stainless steel 1.4301/304, diamond-shaped, wave design - retrofitting possible, material thickness: 1.5 mm

brushed

Item no.
FB-Wave 145-S

brushed

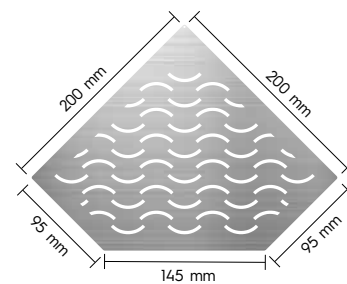

white matt RAL 9003

Item no.
FB-Wave 145-BW

white matt RAL 9003

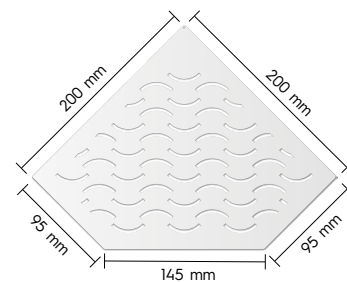

black matt RAL 9005

Item no.
FB-Wave 145-SW

black matt RAL 9005

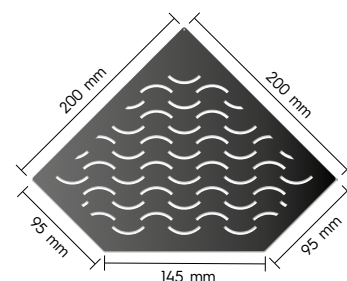

fuma // WALL - SHOWER SHELVES

Stainless steel 1.4301/304, tileable, triangular, **isosceles**, **L-shaped edging** - retrofitting possible

L-shaped edging

Width in mm	Leg length in mm	Item no.
310	220	FB-W 220
355	250	FB-W 250
395	280	FB-W 280

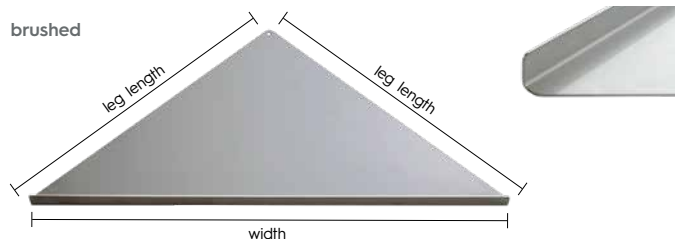

fuma // WALL - SHOWER SHELVES

Stainless steel 1.4301/304, tileable, triangular, **isosceles**, **square edge** - retrofitting possible

Square edge

Width in mm	Leg length in mm	Item no.
310	220	FB-Q 220
355	250	FB-Q 250
395	280	FB-Q 280

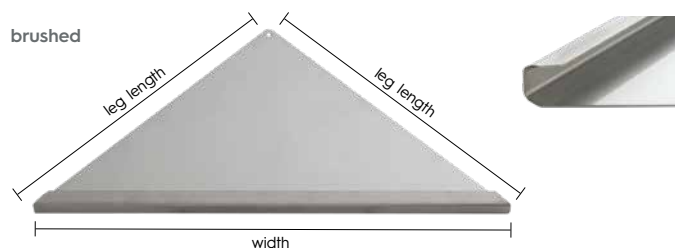

fuma // WALL - SHOWER SHELVES

Stainless steel 1.4301/304, triangular, isosceles, **vintage design** - retrofitting possible

brushed

Width in mm	Leg length in mm	Item no.
340	240	FB-MFA-240 VINTAGE

Includes suspension device for shower sponge or shower squeegee, etc.

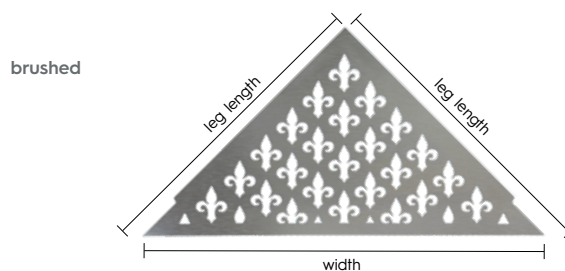

fuma // WALL - SHOWER SHELVES

Stainless steel 1.4301/304, triangular, isosceles, **classic design** - retrofitting possible

brushed

Width in mm	Leg length in mm	Item no.
340	240	FB-MFA-240-CLASSIC

Includes suspension device for shower sponge or shower squeegee, etc.

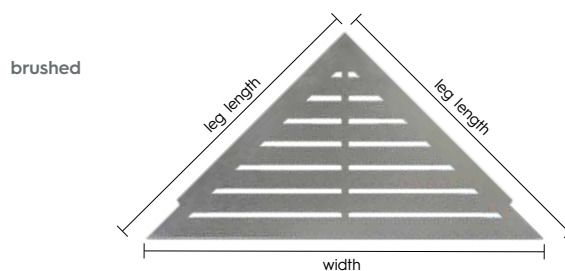

fuma // WALL - NICHEs

Stainless steel 1.4301/304, brushed / white matt / black matt in 3 different sizes

brushed

Dimensions in mm	Item no.
150 x 300 x 100	Niche NES 1530
300 x 300 x 100	Niche NES 3030
600 x 300 x 100	Niche NES 6030

brushed



white matt RAL 9003

Dimensions in mm	Item no.
150 x 300 x 100	Niche NE-BW 1530
300 x 300 x 100	Niche NE-BW 3030
600 x 300 x 100	Niche NE-BW 6030

white matt RAL 9003



black matt RAL 9005

Dimensions in mm	Item no.
150 x 300 x 100	Niche NE-SW 1530
300 x 300 x 100	Niche NE-SW 3030
600 x 300 x 100	Niche NE-SW 6030

black matt RAL 9005



Niche 150 x 300 x 100 mm

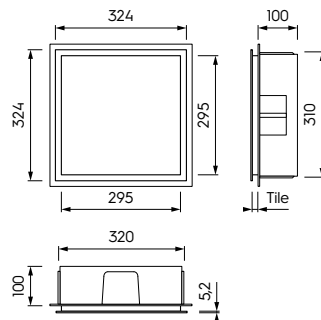

Niche 300 x 300 x 100 mm

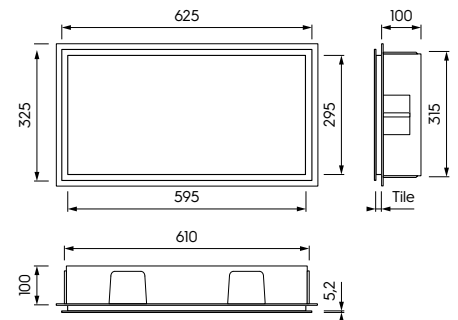

Niche 600 x 300 x 100 mm

// DESCRIPTION

- perfect storage space and elegant storage possibility
- modern and timeless design object - not only in the bathroom
- no more unnecessary mounting of shower baskets
- high quality material
- stainless steel and waterproof
- easy cleaning
- easy installation in wet and dry construction - suitable for all tile thicknesses (Advantage against niches with backsplash for tile)
- Shell construction element and sealing set included (sealing set self-adhesive, width 120 mm)



CONSTRUCTION BOARDS

PAGE 150 - 153





“Construction boards are all-rounders! They not only make walls and floors level, but also water-proof and insulate against cold and noise. They are also easy to work with and save time in many construction projects.”

GENTIAN BALA

part of the fuma-Bautec team
since 2013

fuma // CON - CONSTRUCTION BOARDS

made of extruded rigid polystyrene foam

Thickness in mm	Slab sizes in mm	Item no.	Pieces per pallet	m ² per pallet
4.0	1300 x 600	FWES 13060/4	140	109.20
6.0	1300 x 600	FWES 13060/6	140	109.20
10.0	1300 x 600	FWES 13060/10	100	78.00
10.0	2600 x 600	FWES 26060/10	50	78.00
12.5	2600 x 600	FWES 26060/12	50	78.00
20.0	2600 x 600	FWES 26060/20	50	78.00
30.0	2600 x 600	FWES 26060/30	36	56.16
40.0	2600 x 600	FWES 26060/40	36	56.16
50.0	2600 x 600	FWES 26060/50	26	40.56
60.0	2600 x 600	FWES 26060/60	18	28.08



Freight charges on request.

// DESCRIPTION

- 100% waterproof
- design variety
- optimum adhesive adhesion
- easy cutting
- light weight
- high thermal insulation
- accurate to size & plan level
- frost resistant
- high compressive strength
- free from CFCs

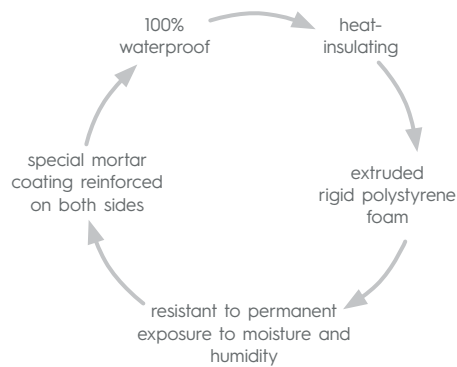

fuma // CON - ANGLE ELEMENTS

made of extruded rigid polystyrene foam

Dimensions in mm	Thickness in mm	Item no.	Pieces per pallet	Length in cm
15 x 15	20.0	FWES 1515/20	60	260.0
20 x 20	20.0	FWES 2020/20	40	260.0
30 x 30	20.0	FWES 3030/20	40	260.0
40 x 20	20.0	FWES 4020/20	40	260.0

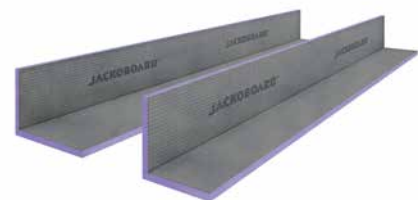

Freight charges on request.

// DESCRIPTION

- assembly element especially for corner constructions and pipe claddings
- special coating on both sides
- directly tileable, fillable and plasterable

fuma // CON – ACCESSORIES CONSTRUCTION BOARDS AND ANGLE ELEMENTS

METAL DOWEL

galvanized steel. 5 pieces/
sqm. 8 mm dowel hole

Length in mm	Item no.
50	FMD 50
80	FMD 80
110	FMD 110
140	FMD 140



WASHERS

for fixing FWES-
Construction boards

Diameter in mm	Item no.
36 / 5.5	FDT-V2A

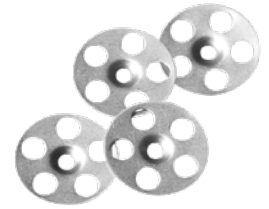

REINFORCING TAPE

self-adhesive

Width in cm	Item no.
15	FAR 150/20



Roll length: 20 m.

fuma // CON – FIBREGLASS AND ARMORING MESH

Fibreglass mesh FG 165

Item no.	Reinforcing tape	Application	Gram / sqm	Mesh size in mm	Roll length in m
FG 165	VWS	inside + outside	165	4 x 4	50

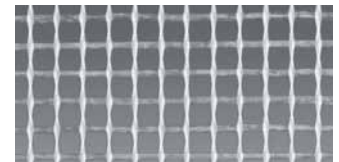

Armoured fabric FP 330

Item no.	Reinforcing tape	Application	Gram / sqm	Mesh size in mm	Roll length in m
FP 330	Armoured fabric	inside + outside	330	6 x 5	25

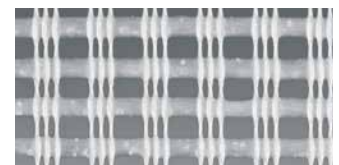



ACCESS COVERS / ADHESIVE FRAMES /
INSPECTION DOORS



“Access covers are used to cover floor openings for underground pipes and shafts. They enable safe access to these systems during maintenance work and at the same time prevent the ingress of foreign objects.”

**GENTIAN BALA &
HEIKO BECK**

part of the fuma-Bautec team
since 2013

fuma // COVER – ACCESS COVER SED
 Stainless steel 1.4301 / 304

Item no.	Light shaft dimension (approx. cm) c x d	Exterior dimensions (approx. cm) A x B	Weight unfulled (approx.) in kgs
SED 22	20 x 20	33.5 x 33.5	7
SED 33	30 x 30	43.5 x 43.5	10
SED 44	40 x 40	53.5 x 53.5	13
SED 55	50 x 50	63.5 x 63.5	16
SED 64	60 x 40	73.5 x 53.5	16
SED 66	60 x 60	73.5 x 73.5	20
SED 86	80 x 60	93.5 x 73.5	24
SED 88	80 x 80	93.5 x 93.5	29
SED 106	100 x 60	113.5 x 73.5	28
SED 108	100 x 80	113.5 x 93.5	34
SED 110	100 x 100	113.5 x 113.5	40

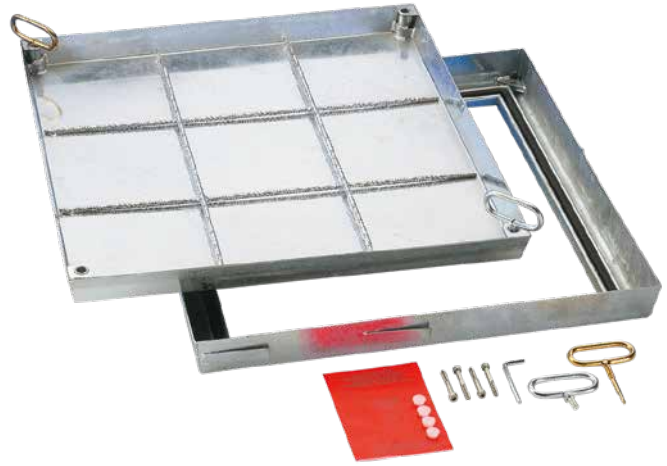

// DESCRIPTION

- **Load:** 125 kN test load.
- **Tub depth** = 5.0 cm
Installation height = 7.5 cm
- **Material:** Stainless steel No. 1.4301. Pickled in a full bath after welding.
- **Properties:** Odor- and waterproof shaft cover in precise workmanship. Particularly easy to open due to conical design. Virtually invisible when installed. Special seal with good chemical resistance.
- **Opening with the lift off system:** Each access cover type SED stainless steel comes with a set of lifting keys and detailed installation instructions. The advantage idea: Fixed tubs are lifted up with the golden lifting key by simply screwing it in.
- **Recommendation for use:** For shafts inside buildings and in forecourt areas where the highest quality is particularly important or where stainless steel is indispensable for hygienic reasons, e.g. in the food industry, meat processing plants, dairies, swimming pools, hospitals, etc.
- **Installation:** Installation must be carried out professionally in accordance with our installation instructions. With waterproof types, special attention must be paid on the construction site to a tight connection to the external side of the frame.



Application example in the food industry

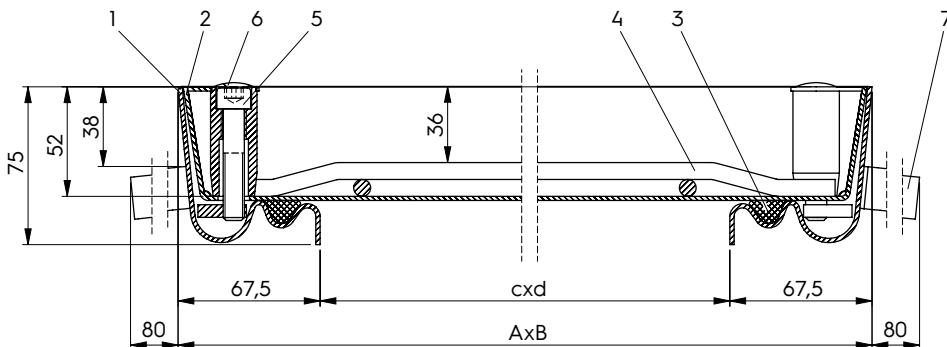

- 1 Frame
- 2 Tub
- 3 Gasket
- 4 Reinforcement
- 5 Hexagon socket screw
- 6 Cover cap
- 7 Anchor

fuma // COVER - ACCESS COVER SSV

Hot-dip galvanized steel

Item no.	Light shaft dimension (approx. cm) c x d	Exterior dimensions (approx. cm) A x B	Weight unfiled (approx.) in kgs
SSV 33	30 x 30	43.5 x 43.5	10
SSV 44	40 x 40	53.5 x 53.5	14
SSV 45	45 x 45	58.5 x 58.5	16
SSV 55	50 x 50	63.5 x 63.5	17
SSV 64	60 x 40	73.5 x 53.5	17
SSV 66	60 x 60	73.5 x 73.5	21
SSV 635	63.5 x 63.5	77.0 x 77.0	23
SSV 86	80 x 60	93.5 x 73.5	26
SSV 88	80 x 80	93.5 x 93.5	31
SSV 106	100 x 60	113.5 x 73.5	30
SSV 108	100 x 80	113.5 x 93.5	36
SSV 110	100 x 100	113.5 x 113.5	42

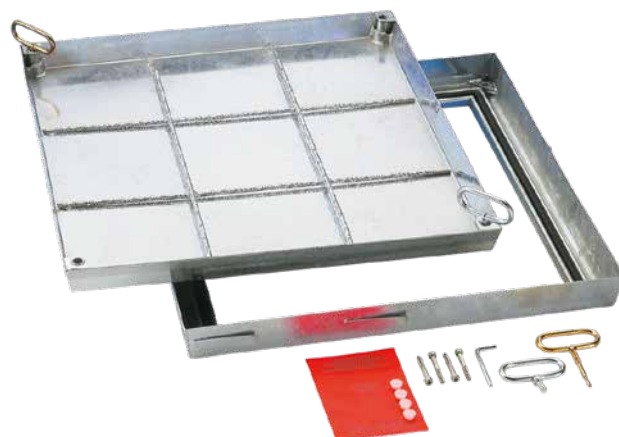
**// DESCRIPTION**

- **Load:** 125 kN test load.
- **Tub depth** = 5.0 cm
Installation height = 7.5 cm
- **Material:** Frame and tub made of 2 mm cold-rolled bending steel profiled with precision tools. Hot-dip galvanized in a full bath.
- **Properties:** Odor- and waterproof access cover in precise workmanship. Particularly easy to open due to conical design. Virtually invisible when installed. Special seal with good chemical resistance. Sturdy ribbed door steel reinforcement.
- **Opening with the lift off system:** Each access cover type SSV steel comes with a set of lifting keys and detailed installation instructions. The advantage idea: Fixed tubs are lifted up with the golden lifting key by simply screwing it in.
- **Recommendation for use:** For shafts inside the building and in the forecourt area, which must be Odor- and watertight.
- **Installation:** Installation must be carried out professionally in accordance with our installation instructions. With watertight types, special attention must be paid on the building site to a tight connection on the outside of the frame.

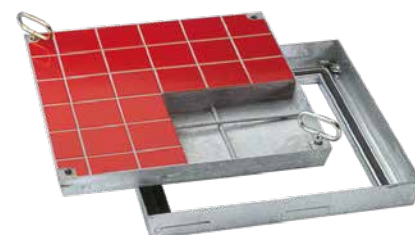

partially filled with tiles

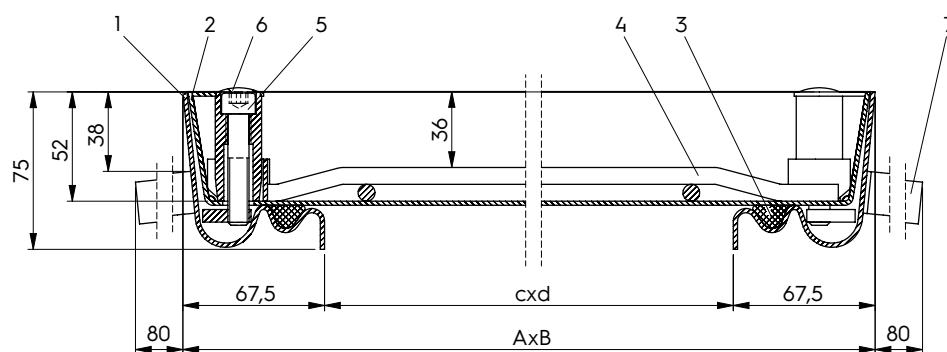

- 1 Frame
- 2 Tub
- 3 Gasket
- 4 Reinforcement
- 5 Hexagon socket screw
- 6 Cover cap
- 7 Anchor

fuma // COVER – ACCESS COVER SAL

Aluminum

Item no.	Light shaft dimension (approx. cm) c x d	Exterior dimensions (approx. cm) A x B	Weight unfilled (approx.) in kgs
SAL 22	20 x 20	32 x 32	3
SAL 33	30 x 30	42 x 42	5
SAL 44	40 x 40	52 x 52	7
SAL 45	45 x 45	57 x 57	8
SAL 55	50 x 50	62 x 62	9
SAL 64	60 x 40	72 x 52	9
SAL 66	60 x 60	72 x 72	10
SAL 635	63.5 x 63.5	75.5 x 75.5	11
SAL 77	70 x 70	82 x 82	12
SAL 86	80 x 60	92 x 72	12
SAL 88	80 x 80	92 x 92	15
SAL 106	100 x 60	112 x 72	15
SAL 108	100 x 80	112 x 92	21
SAL 110	100 x 100	112 x 112	23



// DESCRIPTION

- **Load:** 125 kN test load.
- **Tub depth** ≈ 6.6 cm
Installation height ≈ 7.6 cm
- **Material:** Frame and tub made of extruded aluminum profiles. Stainless steel screws.
- **Properties:** Absolutely Odor- and waterproof access cover in very high processing quality. Tightness guarantee up to 1000 mm water column. Test certificate available. Very nice surface, especially the visible edges. Particularly suitable where an elegant appearance is decisive. The construction is very easy to open. Sturdy corner connectors guarantee a very high rigidity and facilitate the laying of tiles and ceramic coverings. Good chemical resistant special sealing. The tub is reinforced with a clamped rib gate steel reinforcement.
- **Opening with the lift off system:** Each access cover type SAL Alu comes with a set of lifting keys and detailed installation instructions. The advantage idea: Fixed tubs are lifted up with the golden lifting key by simply screwing it in.
- **Recommendation for use:** For shafts inside buildings which should look good and everywhere where floor coverings are still being sanded or where particular attention must be paid to corrosion resistance.
- **Installation:** Installation must be carried out professionally in accordance with our installation instructions. With waterproof types, special attention must be paid on the construction site to a tight connection on the outside of the frame and to filling the tub with waterproof concrete.



partially filled with tiles



built-in in the office (cleaning shaft), lined with carpet

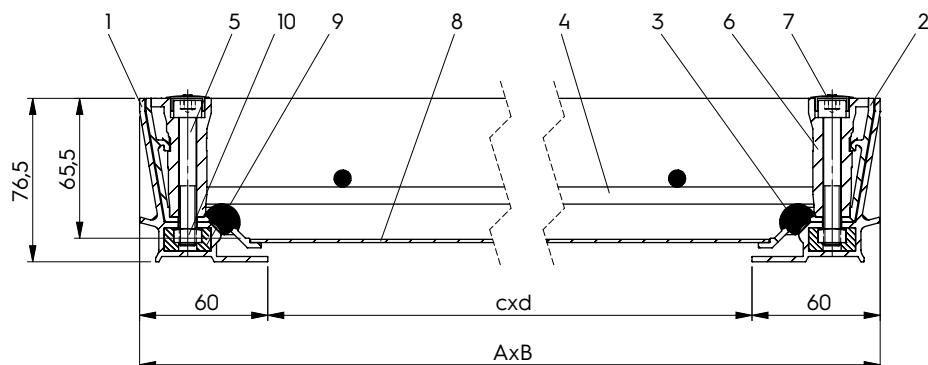

- 1 Frame
- 2 Tub
- 3 Gasket
- 4 Reinforcement
- 5 Hexagon socket screw (stainless steel)
- 6 Die-cast corner (aluminum)
- 7 Cover cap (plastic)
- 8 Base plate
- 9 Molded part (plastic)
- 10 Square nut (stainless steel)

fuma // COVER – ACCESS COVER SAL-SL

Aluminum

Item no.	Light shaft dimension (approx. cm) c x d	Exterior dimensions (approx. cm) A x B	Weight unfilled (approx.) in kgs
SAL-SL 22	20 x 20	29 x 29	2
SAL-SL 33	30 x 30	39 x 39	3
SAL-SL 44	40 x 40	49 x 49	4
SAL-SL 45	45 x 45	54 x 54	5
SAL-SL 55	50 x 50	59 x 59	6
SAL-SL 64	60 x 40	69 x 49	6
SAL-SL 66	60 x 60	69 x 69	7
SAL-SL 635	63.5 x 63.5	72.5 x 72.5	8
SAL-SL 77	70 x 70	79 x 79	9
SAL-SL 86	80 x 60	89 x 69	9
SAL-SL 88	80 x 80	89 x 89	10
SAL-SL 106	100 x 60	109 x 69	10
SAL-SL 108	100 x 80	109 x 89	12
SAL-SL 110	100 x 100	109 x 109	14



// DESCRIPTION

- **Load:** 15 kN test load.
- **Tub depth** ≈ 39 mm / 14 mm (around the edge)
Installation height ≈ 5.0 cm
- **Material:** Frame and tub made of extruded aluminum profiles. Stainless steel screws.
- **Properties:** Odor- and waterproof access cover in very high quality. Only 5 cm installation height. Especially for installation situations that do not allow a greater installation height. The low tub results in weight savings when filled – the effort required to open is reduced. A free height of 14 mm is available for files, parquet etc. Two chemical-resistant special seals. The tub is reinforced with a clamped rib gate steel reinforcement.
- **Opening with the lift off system:** Each access cover type SAL-SL Alu comes with a set of lifting keys and detailed installation instructions. The advantage idea: Fixed tubs are lifted up with the golden lifting key by simply screwing it in.
- **Recommendation for use:** For shafts inside buildings which should look good and everywhere where floor coverings are still being sanded or where particular attention must be paid to corrosion resistance.
- **Installation:** Installation must be carried out professionally in accordance with our installation instructions. With waterproof types, special attention must be paid on the construction site to a tight connection on the outside of the frame and to filling the tub with waterproof concrete.



partially filled with tiles

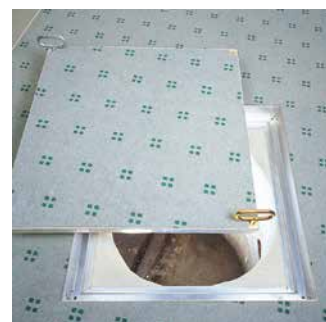

built-in in the office (cleaning shaft), laid out with carpet

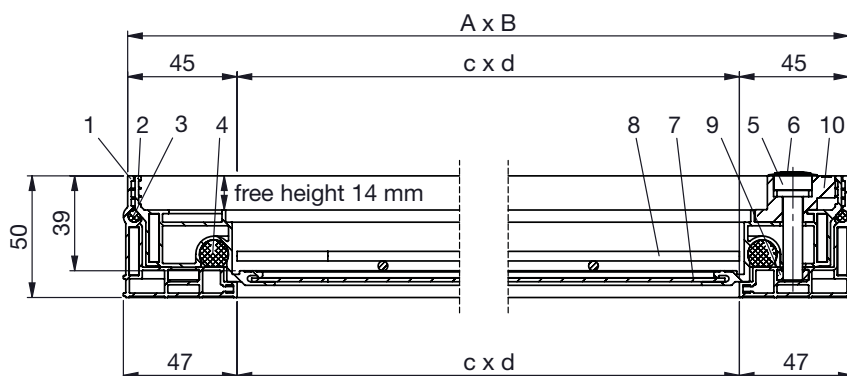

- 1 Frame
- 2 Tub
- 3 Upper seal
- 4 Lower seal
- 5 Hexagon socket screw (stainless steel)
- 6 Cover cap (plastic)
- 7 Tub plate (aluminum)
- 8 Reinforcement
- 9 Nut (stainless steel)
- 10 Cast part (aluminum)

fuma // COVER – ADHESIVE FRAMES

Stainless steel 1.4301/304, with grating, surface: brushed

Dimension: 100 x 100 mm

Tile thickness Height in mm	Item no.
6.0	FKL 100/06
-	-
10.0	FKL 100/10
-	-

Dimension: 150 x 150 mm

Tile thickness Height in mm	Item no.
6.0	FKL 150/06
8.0	FKL 150/08
10.0	FKL 150/10
-	-

Dimension: 200 x 200 mm

Tile thickness Height in mm	Item no.
-	-
8.0	FKL 200/08
10.0	FKL 200/10
12.0	FKL 200/12

Dimension: 250 x 250 mm

Tile thickness Height in mm	Item no.
-	-
8.0	FKL 250/08
10.0	FKL 250/10
-	-

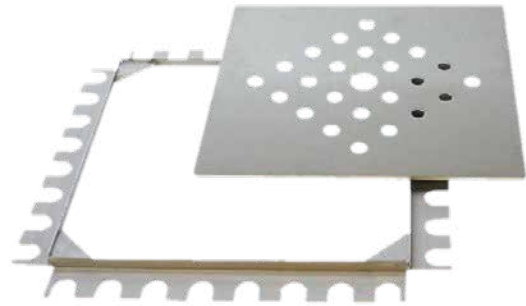

// DESCRIPTION

Adhesive frame made of stainless steel with grating

The adhesive frame is glued into the new tile covering, directly above the old floor drain. The grate is only inserted. Ideal for renovation and refurbishment, e.g. when a new tile covering is glued to an old covering. The rust lies on 4 fixed points and is so stable that there are no deflections. The polished surface of the stainless steel grating makes it ideal for most tile colors. Available in various formats and tile thicknesses.

fuma // COVER – TILE MAGNETS

Item no.
FFMG 100

1 set consisting of:

- 4 special magnets
- 4 counterplates



fuma // COVER – MAGNET TILE FRAME

PVC, with galvanized, tileable carrier plate

Installation dimension H x W in mm	Internal dimension H x W in mm	Item no.
156 x 156	150 x 150	FRP 100/10
156 x 309	150 x 303	FRP 100/15
309 x 309	303 x 303	FRP 100/20
206 x 206	200 x 200	FRP 100/40
206 x 409	200 x 403	FRP 100/45
156 x 206	150 x 200	FRP 100/50
206 x 309	200 x 303	FRP 100/55
309 x 409	303 x 403	FRP 100/60
409 x 409	403 x 403	FRP 100/65
256 x 256	250 x 250	FRP 100/70
206 x 256	200 x 250	FRP 100/75



// DESCRIPTION

→ **Properties:** Quick and easy access to the „interior“ of tiled bathtubs, wall elements, also suitable for tiled kitchen walls with concealed fittings, counters, etc. The white frame optically replaces the joint, thus practically invisible. The opening of the tiled support plate is very easy, e.g. with a rubber suction cup, for example. Also suitable for installation in plasterboard walls and similar materials.

→ **Frame material:** Hard PVC, white, 3 mm thick. Installation depth: 30 mm for tile thicknesses up to 11 mm. Reinforcement angle: in the corners from size 500 mm leg length. Holding magnets (height adjustable): hold the tileable carrier plate firmly in the frame. The tile height can be adjusted by 4 mm by turning the magnets. The holding force of the magnets is approx. 2 - 3 kgs/piece. Depending on the model size, they are attached in sufficient quantities. Carrier plate: (for gluing on the tiles) galvanized sheet steel, 0.8 - 1.25 mm thick, depending on size.

fuma // COVER – INSPECTION DOORS

Galvanized sheet steel, surface: color coated white

Installation dimension H x W in mm	External dimension H x W in mm	Item no.
150 x 150	185 x 185	FRT 540/10
200 x 200	235 x 235	FRT 540/20
250 x 200	285 x 235	FRT 540/25
250 x 250	285 x 285	FRT 540/30
300 x 200	335 x 235	FRT 540/40
300 x 250	335 x 285	FRT 540/45
300 x 300	335 x 335	FRT 540/50
400 x 200	435 x 235	FRT 540/55
400 x 300	435 x 335	FRT 540/60
400 x 400	435 x 435	FRT 540/65
600 x 400	635 x 435	FRT 540/90
600 x 500	635 x 535	FRT 540/95
600 x 600	635 x 635	FRT 540/99



// ACCESSORIES

Socket wrench square

Item no.
FRTU

// DESCRIPTION

→ **Properties:** The universal door for wall installation, e.g. for concealed meters and other fittings that are frequently serviced. Door leaf can be removed for left- or right-sided installation. Simple and safe installation due to riveted and swivelling wall brackets. Also suitable for installation in plasterboard walls and similar materials.

→ **Material:** Galvanized sheet steel, 0.75 - 1.00 mm thick depending on size. Surface: White color coated RAL 9016. Frame: The cover frame, depending on size in a width of 19 - 24 mm, in decorative slightly curved form, is used for clean facing of tiles and or wall edges. Closure: A recessed 7 mm square closure is fitted as standard. A suitable key can be supplied on request.



“Swimming pool gratings are essential for a safe and hygienic swimming environment. They serve to reliably drain overflow water and at the same time provide a safe, non-slip transition between the pool edge and the circulation area. Thanks to their special surface structure, they help to prevent injuries.”

**JÜRGEN RATH &
VEPRIM BALA-SCHIPPKE**

part of the fuma-Bautec team
since 2000 / 2012

SWIMMING POOL GRATINGS

PAGE 162 - 165



fuma // POOL – FLOOD GRATING CAN BE ROLLED UP

transverse to the pool edge

Profile height in mm	Item no.	Grate width 100 - 150 mm € / lm	Grate width 151 - 200 mm € / lm	Grate width 201 - 250 mm € / lm	Grate width 251 - 300 mm € / lm	Grate width 301 - 340 mm € / lm	Grate width 341 - 360 mm € / lm	Grate width 361 - 400 mm € / lm	Grate width 401 - 450 mm € / lm	Grate width 451 - 500 mm € / lm
22.0	FRA 22/10	on request	on request	on request	on request	-	-	-	-	-
25.0	FRA 25/10	on request	on request	on request	on request	on request	-	-	-	-
27.0	FRA 27/10	on request	on request	on request	on request	on request	on request	-	-	-
35.0	FRA 35/10	on request	on request	on request	on request	on request	on request	on request	on request	on request

// DESCRIPTION

- **Properties:** Constructed from premium-grade plastic, entirely resistant to corrosion, chlorine, seawater, and heating water. Bar tops feature safety profile embossing, with a profile width of 10 mm. Surfaces are rounded, and smooth designs are available upon request. Special configurations such as corner variations (mitre corners, fan corners, and blunt corners) and radial components are also offered.
- **Application:** Suitable for both public and private swimming pools equipped with flood gutters, as well as whirlpools
- **Standard colors:** white, grey and beige.
- **Custom widths:** Available upon request.



fuma // POOL – FLOOD GRATE RIGID

longitudinal to the pool edge

Profile height in mm	Item no.	Grate width 100 - 150 mm € / lm	Grate width 151 - 200 mm € / lm	Grate width 201 - 250 mm € / lm	Grate width 251 - 300 mm € / lm	Grate width 301 - 340 mm € / lm	Grate width 341 - 360 mm € / lm	Grate width 361 - 400 mm € / lm	Grate width 401 - 450 mm € / lm	Grate width 451 - 500 mm € / lm
22.0	FRS 22/10	on request	on request	on request	on request	-	-	-	-	-
25.0	FRS 25/10	on request	on request	on request	on request	on request	-	-	-	-
27.0	FRS 27/10	on request	on request	on request	on request	on request	-	-	-	-
35.0	FRS 35/10	on request	on request	on request	on request	on request	-	-	-	-

// DESCRIPTION

- **Properties:** Constructed from premium-grade plastic, entirely resistant to corrosion, chlorine, seawater, and heating water. Bar tops feature safety profile embossing, with a profile width of 10 mm. Surfaces are rounded, and smooth designs are available upon request. Special configurations such as corner variations (mitre corners, fan corners, and blunt corners) and radial components are also offered. (Radial shaped parts only available for FRS 25/10 and FRS 27/10).
- **Application:** Suitable for both public and private swimming pools equipped with flood gutters, as well as whirlpools with flood gutters.
- **Standard colors:** white, grey and beige.
- **Custom widths:** Available upon request.

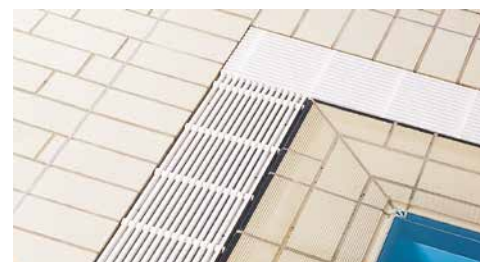

fuma // POOL – FLOOD GRATE RIGID

transverse to the pool edge

// 295 MM STANDARD LENGTH

Profile height in mm	Item no.	Standard width		
		Grate width 200 mm € / lm	Grate width 300 mm € / lm	Grate width 400 mm € / lm
22.0	FRE 22/10	on request	on request	on request

Profile height in mm	Item no.	Special width		
		Grate width 110 - 200 mm € / lm	Grate width 201 - 300 mm € / lm	Grate width 301 - 400 mm € / lm
22.0	FRE 22/10	on request	on request	on request

Standard length: 295 mm

// 885 MM LONG SECTIONS

Profile height in mm	Item no.	Standard width		
		Grate width 200 mm € / lm	Grate width 300 mm € / lm	Grate width 400 mm € / lm
22.0	FRK 22/10	on request	on request	on request

Profile height in mm	Item no.	Special width		
		Grate width 110 - 200 mm € / lm	Grate width 201 - 300 mm € / lm	Grate width 301 - 400 mm € / lm
22.0	FRK 22/10	on request	on request	on request

Length: Three standard elements consisting of 295 mm long individual parts are joined to form 885 mm long sections with an absolutely firm connection.

// DESCRIPTION

→ **Properties:** Crafted from top-grade plastic, entirely resistant to corrosion, chlorine, seawater, and heating water. Bar tops feature safety profile embossing with a 10 mm profile width. Surfaces are rounded. Flood gratings of types FRE 22/10 and FRK 22/10 offer exceptional value for money thanks to construction-related manufacturing advantages.

→ **Standard colors:** white, grey and beige.

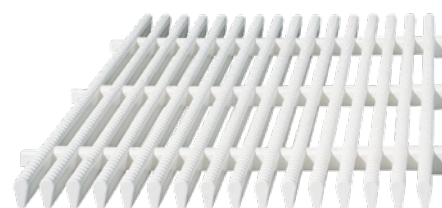

fuma // POOL – SWIMMING POOL GRATING ACCESSORIES

Mitre corners

Item no.
TYP FRA
TYP FRS
TYP FRK



Fan corners

Item no.
TYP FRA
TYP FRS
TYP FRK



Rigid corners

Item no.
TYP FRA
TYP FRS
TYP FRK



Radii: 2 Connections

Item no.
TYP FRA
TYP FRS
TYP FRK

Radii: 3 Connections

Item no.
TYP FRA
TYP FRS
TYP FRK

up to grate width = 300 mm

up to grate width = 500 mm



ACCESSORIES

PAGE 166 - 175



“Reliable tools are important. Our diamond discs, cutting discs and core bits not only offer outstanding performance, but are also easy to handle. This saves our customers time and allows them to concentrate on their projects.”

INGO BECK

part of the fuma-Bautec team
since 2009

fuma // TOOL - HIGH-END DIAMOND DISCS

thickness: 1.3 mm, ornamental segment, reinforced flange, especially for ultra-hard porcelain stoneware

Item no.	Diameter in mm
FT-BT 115	115
FT-BT 125	125

Suitable for all commercially available angle grinders.
Low-vibration cutting due to reinforced flange.

**fuma // TOOL - CUTTING DISCS**

thickness: 1.0 mm, for steel and stainless steel

Item no.	Diameter in mm
FT-IF 115	115
FT-IF 125	125

Suitable for all commercially available angle grinders.
Perfect for cutting tile profiles.

**fuma // TOOL - DIAMOND CORE BIT SET**

consisting of 4 core bits

Item no.	Diameter in mm
FT-BK/Set	each 1x 35/40/50/68

**// VALID FOR ALL CORE BITS**

Mounting: M 14, suitable for all commercially available angle grinders.
Extremely long service life due to the latest production technology in the vacuum process. Suitable for all types of porcelain stoneware, granite and marble.

fuma //TOOL – DIAMOND CORE BITS WITH INTERNAL COOLING

Item no.	Diameter in mm
F-BK 006	6
F-BK 008	8
F-BK 010	10
F-BK 012	12
F-BK 014	14

With paraffin filling



fuma //TOOL – DIAMOND END MILL / GRINDING END MILL

Item no.	Diameter in mm
F-BF 008-STIFT	8



fuma //TOOL – DIAMOND CORE BITS

Item no.	Diameter in mm
F-BK 020	20
F-BK 027	27
F-BK 030	30
F-BK 035	35
F-BK 040	40
F-BK 045	45
F-BK 050	50
F-BK 055	55
F-BK 060	60
F-BK 065	65
F-BK 068	68
F-BK 075	75



fuma // TOOL - WEDGE LEVELLING SYSTEM STARTER SET

for 2 mm joint width

Starter Set L

Item no.
FBN-ST 100 L

- 100 Pull straps
- 100 Wedges
- 1x Metal pliers

Starter Set XL

Item no.
FBN-ST 250 XL

- 250 Pull straps
- 250 Wedges
- 1x Metal pliers



fuma // TOOL - LEVELLING STRAPS WHITE / TRANSPARENT

500 pieces / bag

Joint width: 1 mm

Item no.	Tile thickness in mm
FBN-LA 610	3 - 12
-	-

Joint width: 1.5 mm

Item no.	Tile thickness in mm
FBN-LA 715	3 - 12
-	-

Joint width: 2 mm

Item no.	Tile thickness in mm
FBN-LA 500	3 - 12
FBN-LA 925	15 - 25



Joint width: 3 mm

Item no.	Tile thickness in mm
FBN-LA 830	3 - 12
FBN-LA 935*	15 - 25

Joint width: 4 mm

Item no.	Tile thickness in mm
-	-
FBN-LA 945*	15 - 25

* 250 pieces / bag

fuma // TOOL - LEVELLING WEDGES

250 pieces / bag, with grid, reusable

Item no.
FBN-KE 250



fuma // TOOL - LEVELLING PLIERS

made of metal or PVC

Metal

Item no.
FBN-ZANGE/MET

PVC

Item no.
FBN-ZANGE/KUN



Figure: Metal pliers

fuma //TOOL – SCREW LEVELLING SYSTEM STARTER SET

for 1.5 mm joint width

Starter Set

Item no.
FBN-PRE-SET 100/250-OR

- 100 Turning heads
- 250 Threaded shackles

**fuma //TOOL – THREADED SHACKLES TRANSPARENT**

250 pieces / bag

Joint width: 1.5 mm

Item no.	Tile thickness in mm
FBN-PRE-LA 150-TR	3 - 20

Joint width: 2.0 mm

Item no.	Tile thickness in mm
FBN-PRE-LA 200-TR	3 - 20

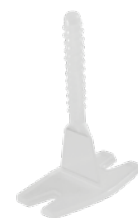
**fuma //TOOL – TURNING HEADS ORANGE**

100 pieces / bag

Item no.	Tile thickness in mm
FBN-PRE-Dreh 100	3 - 20

**fuma //TOOL – PROTECTIVE PLATES FOR TILES / NATURAL STONE**

100 pieces / bag

SUITABLE FOR BOTH LEVELLING SYSTEMS

Item no.
FBN-Universal 100/S



fuma //TOOL - OTTOSEAL® S100

premium sanitary silicone

Item no.	Form of delivery
FS 100/300	300 ml

→ **Colors:** Available colors see page 174 (fungicidally treated).

- **Fields of application:** Sealing in sanitary areas, connection joints between door and window frames and masonry, window and door rebate sealing against draughts, dust and noise; Profilit glazing. SB area. Elastic silicone sealant, acetate cross-linking.
- **Pre-treatment of the joints:** The joint flanks must be clean, grease-free and load-bearing. Priming is not required for glass, ceramics, enamel, aluminum, sanitary acrylic.

**fuma //TOOL - OTTOSEAL® S70**

premium natural stone silicone

Item no.	Form of delivery
FS 70/310	310 ml

→ **Colors:** Available colors see page 175.

- **Fields of application:** Grouting and sealing on marble and natural stone. No soiling of edge zones: due to high tear and notch resistance also suitable for expansion joints in the floor area (inside and outside). Silicone sealant - neutral cross-linking.
- **Pre-treatment of the joints:** The joint flanks or adhesive surfaces must be clean, grease-free, dry and load-bearing. In order to achieve optimum adhesion, natural stone exposed to wet conditions and certain natural stone not exposed to wet conditions must be pre-treated with a primer. Pre-treat sandstone with primer. Use a marble silicone smoothing agent.

**fuma //TOOL - OTTOSEAL® S130**

with extended mold protection, sanitary and natural stone silicone

Item no.	Form of delivery
FS 130/310	310 ml

→ **Colors:** Available colors see page 175 (fungicide treated).

- **Fields of application:** Sealing and grouting in sanitary rooms with high demands on silicone grouting, e.g. in damp rooms, public shower and bath areas, swimming pools, sports facilities, fitness studios, hospitals, thermal baths, wellness areas, hotel bathrooms, etc. For grouting ceramic tiles and natural stone in permanently wet areas.
- **Properties:** Neutral cross-linking 1-component silicone sealant based on alkoxy. Fungicide treated with the health and ecological safe OTTO Fungitect silver technology. Very good resistance to weathering, ageing and UV radiation. Does not pollute the edge zones of natural stone. Low odor.

**fuma //TOOL - OTTOSEAL® S140**

with extended mold protection, the swimming pool and natural stone silicone

Item no.	Form of delivery
FS 140/310	310 ml

→ **Colors:** Available colors see page 175 (fungicidally treated).

- **Fields of application:** Sealing and grouting in sanitary rooms with high demands on silicone grouting, e.g. in damp rooms, public shower and bath areas, swimming pools, sports facilities, fitness studios, hospitals, thermal baths, wellness areas, hotel bathrooms, etc. For grouting ceramic tiles and natural stone in permanently wet areas. Sealing of swimming pools and baths and elastic joints at the pool head. Well suited for floor joints.
- **Properties:** Neutral cross-linking 1-component silicone sealant based on alkoxy. Fungicide treated with the health and ecological safe OTTO Fungitect silver technology. Very good resistance to weathering, ageing and UV radiation. Guaranteed not to cause soiling of the edge zones of natural stone. High notch resistance. Well suited for floor joints.



fuma //TOOL – OTTOCOLL® M500

the water-resistant premium hybrid sealant

Item no.	Form of delivery	→ Color: grey
FS 500/310	310 ml	

→ **Fields of application:** For indoor and outdoor use. For tension-equalizing bonding and assembly of a wide variety of materials such as wood, wood-based materials, glass, metals (e.g. aluminum, stainless steel, anodized aluminum, brass, copper), plastics (e.g. rigid PVC, soft PVC, GRP, etc.), mineral substrates (e.g. bricks, tiles, ceramics), fire-resistant building boards (gypsum plasterboard, etc.). For car body and vehicle construction, wagon and container construction, metal and apparatus construction, shipbuilding, a wide variety of construction applications such as staircase construction, etc. Bonding of lacquered and enamelled glass, bonding of stone, natural stone and ceramics.

→ **Properties:** 1K adhesive and sealant based on hybrid polymer STPU. Very good primerless adhesion on numerous substrates - even under water load. Very high mechanical strength, notch resistance and tear resistance. For tension-equalizing bondings and dynamic loads. Free of Isocyanates, silicone-free, low odor, good weathering and ageing resistance, compatible with paints and varnishes/DIN 52452.

**fuma //TOOL – OTTOCOLL® RAPID**

super fast power adhesive

Item no.	Form of delivery	→ Color: beige
FS 150/310	310 ml	

→ **Fields of application:** For construction, dismantling, assembly. For gluing, mounting, repairing materials such as wood and wood-based materials, metal (aluminum, stainless steel, copper, etc.), stone, natural stone, ceramics, bricks, plastics (rigid PVC, GFK, etc.), insulating materials (polystyrene, PU, etc.), fire-resistant building boards (plasterboard, etc.). Meets the requirements of DIN EN 204-D4 for weather-resistant bondings.

→ **Properties:** Stable PU adhesive, extremely fast curing, extremely high adhesive strength, short pressing and fixing times, almost universally applicable, solvent-free and odorless.

**fuma //TOOL – OTTOSEAL® A205**

the premium acrylic sealant

Item no.	Form of delivery	→ Colors: white, concrete grey, brown and black.
FS 205/310	310 ml	

→ **Fields of application:** Primarily suitable for interior finishing, but can easily be used outdoors at temperatures above +5°C. Expansion and connection joints with only low stress, e.g. between wooden window or door frames and masonry, plaster or concrete. Joints and connections to concrete, cellular concrete, plaster, masonry, wood, gypsum plasterboard, fibre cement, roller shutter boxes, window sills, etc.

→ **Properties:** 1-component acrylate sealant. Permissible total deformation 18% paint compatibility according to DIN 52452, good UV resistance. Can be stored and transported at max. -10° C for up to 48 hours.

**fuma //TOOL – OTTOSEAL® A210**

the inexpensive acrylic sealant



Item no.	Form of delivery	→ Colors: white and concrete grey.
FS 210/310	310 ml	

→ **Fields of application:** Expansion and connection joints with only low stress, e.g. between wooden window or door frames and masonry, plaster or concrete. Joints and connections to concrete, cellular concrete, plaster, masonry, wood, gypsum plasterboard, fibre cement, roller shutter boxes, etc.

→ **Properties:** Acrylate-based sealant, practical movement absorption 10%. Very good paint compatibility according to DIN 52452.



fuma // TOOL - COLOR OVERVIEW OTTOSEAL® S100

								
C00 transparent	C01 white	C116 snow white	C51 off-white	C45 chinchilla	C38 light grey	C71 joint grey	C70 grey white	C787 flash grey
								
C230 fog	C94 silver grey	C910 silver grey Nr. 17	C77 silky grey	C776 grey 15	C43 manhattan	C961 morning grey	C86 pale grey	C81 thistle grey
								
C501 light grey Nr. 21	C79 stone grey	C1010 greyish red	C2044 sand grey 18	C18 sanitary grey	C72 flannel grey	C1105 basalt	C1172 titanium grey	C1170 old grey
								
C52 platinum grey	C62 agate grey	C706 cement grey Nr. 31	C56 concrete grey	C02 grey	C1168 light graphite	C67 anthracite	C808 asphalt grey	C24 crocus
								
C91 aegean	C695 ægeisblue	C40 mint	C11 mossy green	C92 whisper blue	C753 crocus blue	C25 bermuda	C42 sorrento blue	C1107 vanilla beige
								
C69 joint white	C08 jasmine	C84 pergamon	C1106 beach beige	C55 natural	C1169 melba	C22 anemone	C103 sahara	C10 bahama beige
								
C82 red beige	C09 caramel	C60 umbra	C19 curry	C15 medium brown	C1167 tobacco brown	C07 fawn brown	C05 brown	C21 bali
								
C75 cottofuge	C23 magnolia	C74 pastel beige	C27 stella	C26 sunset	C1104 almond brown	C04 black	C5176 velvet black	C59 ruby
								
C35 fiery red	C511 gold effect	C510 silver effect	C14 aluminum					

fuma // TOOL - COLOR OVERVIEW OTTOSEAL® S70



// STRUCTURE COLORS



// MATT COLORS



fuma // TOOL - COLOR OVERVIEW OTTOSEAL® S130



fuma // TOOL - COLOR OVERVIEW OTTOSEAL® S140



A photograph of a workbench with various metal profiles and a spool of wire. In the background, a black display board holds several horizontal metal strips in different colors: silver, blue, gold, and white. To the right, a large spool of silver wire sits on a blue base. In the foreground, several metal profiles of different shapes and sizes are scattered on a light-colored wooden surface. A white sign with the 'fuma-Bautec' logo and website is visible on the left.

fuma-Bautec
www.fuma-bautec.com

“We know how important the right tile profile is for your project. That's why we are happy to offer you our sample chains and counter displays. This allows you to check the shapes, colors and surfaces at your leisure and make sure they match the tile perfectly.”

**SASKIA NITSCHÉ &
GENTIAN BALÁ**

part of the fuma-Bautec team
since 2019 / 2013

PROMOTION

PAGE 176 - 180



fuma // PROMOTION - COUNTER DISPLAY

with 15 pcs. of tile profiles

Item no.
Counter Display



fuma // PROMOTION - SAMPLE CHAINS TILE PROFILES

with different type of profiles

Item no.
Sample chain novelties 2025
Sample chain L-shaped edging profiles
Sample chain Square edge profiles
Sample chain Round edge profiles

Sample lengths: 15 cm

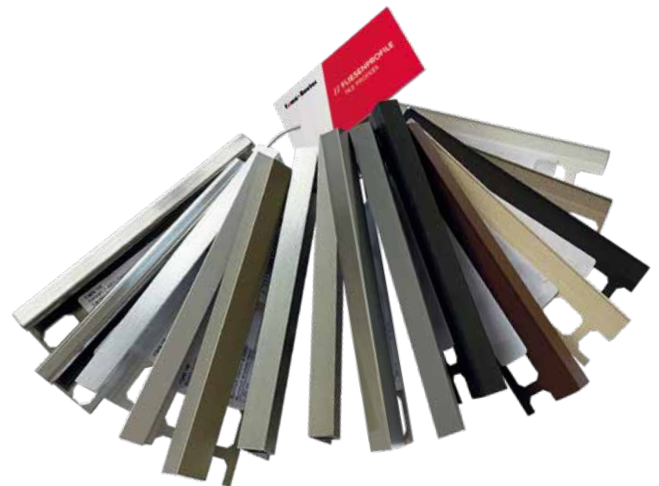

fuma // PROMOTION – COUNTER DISPLAY SHOWER SHELVES

FB-Line / FB-Wave

Item no.
Counter display FB-Line/Wave

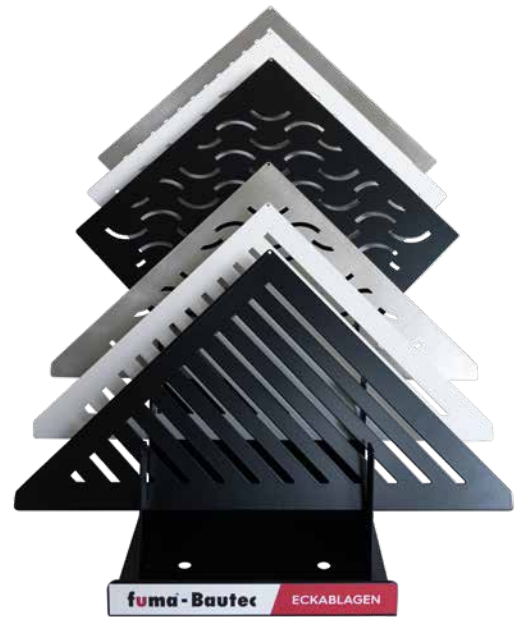

fuma // PROMOTION – COUNTER DISPLAY SHOWER CHANNEL

FD-Line

Item no.
Counter display FD-Line



fuma // PROMOTION – SAMPLE FOLDER MATTING SYSTEMS

with different product samples

Item no.
Sample folder matting systems



fuma // PROMOTION – TILE PROFILE DISPLAY

to the clearly arranged presentation of your assortment

Item no.
Tile profile display 125 with flexible seperators
Tile profile display 66.5 with flexible seperators
Display of accessories 125
Head display mount 125
Head display mount 66.5
Perforated blister plate set left/right
Tray divider 66.5 for short profiles

- **element wide:**
width: 126 cm
height: 206 cm
depth: 57 cm
- **element narrow:**
width: 69 cm
height: 206 cm
depth: 57 cm

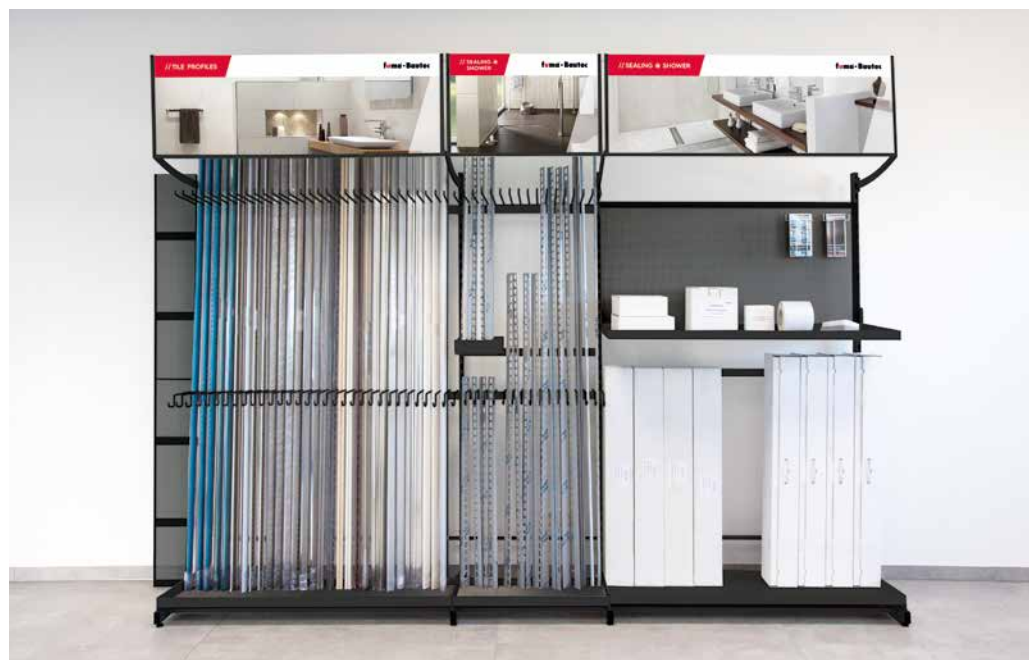

// STRONG TEAM. STRONG PERFORMANCE.



Thanks to the best
warehouse team!

Without you, such a great
photo shoot would not have
been possible!

ARTEM HEINZ, ERAND ZOGU,
OLIVER SEIDEL, IMER ASANI,
GENTIAN BALA, INGO BECK,
VEPRIM BALA-SCHIPPKE,
HEIKO BECK & SASKIA NITSCHKE

fuma // INFO – MAINTENANCE FOR TILE PROFILES

// STAINLESS STEEL 304

Withstands high mechanical stress. Stainless steel is particularly resistant to most chemical products, diluted acids and alkalis. Avoid contact with hydrochloric acid and unalloyed steel tools. When sawn, stainless steel loses its rust resistance at the cutting edges, so separate rust protection should be applied. Cutting dust or sparks must be removed immediately (risk of flash rust). For special cases, stainless steel profiles are partly also available in 316L quality (even higher rust resistance than 304).

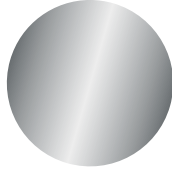

// ALUMINUM

Designed for medium mechanical strength. Sensitive to alkaline materials, e.g. this can lead to strong stains (oxidation spots) with fresh cement. Mortar and grout must always be wiped off immediately with plenty of clean water on visible surfaces. Once oxidation stains are present, they are very difficult to remove.

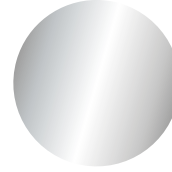

// ALUMINUM ANODIZED

Anodizing is a special, optically enhancing surfacing finish for aluminum profiles. Aluminum anodizing is available in the colors silver, gold, champagne and titanium. The anodized aluminum is sensitive to scratches and may discolor when combined with alkaline construction chemicals. Contact with fresh cement can lead to etching of the surface. Mortar and joint residues on visible surfaces must always be wiped off immediately with plenty of water. Once oxidation spots are present, they can hardly be removed. Only pH-neutral cleaning agents without abrasive components should be used.

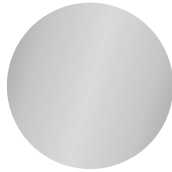
// ALUMINUM
COLOR COATED

Painted in a special process with paint powder. Thus harder and more durable than normal lacquering. UV-stable, good chemical resistance. Visible surfaces are sensitive to scratches. Use cleaning agents without abrasive components.

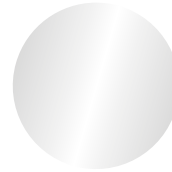

// BRASS

Designed for high mechanical strength. Brass oxidizes (patinizes) in air. When used in damp rooms or in conjunction with aggressive media, oxidation may increase or stains may form on visible parts. If necessary, brass profiles should be polished with special cleaning pastes, so that they can look coppery afterwards. In the case of elastic connection joints, only neutrally crosslinking silicone should be used (risk of corrosion).

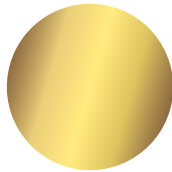

// PVC

Conditionally mechanically loadable, can only be used as edge protection against light impacts. Colored profiles are UV-stable under normal circumstances, but color differences may occur with constant UV irradiation. Insensitive to diluted acids and alkalis, e.g. chlorinated water. Resistant to fungi and bacteria.

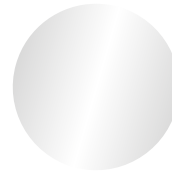

// THIS APPLIES TO ALL MATERIALS

- When laying and grouting metal tile rails (aluminum, stainless steel and brass), adhesive and grouting materials must be removed immediately with fresh clear water and a soft, non-scratching sponge in order to avoid corrosion damage to the profiles.
- Do not use acidic (e.g. cement residue remover) or alkaline cleaning agents in combination with all metal profiles.
- Clean with clear water and dry a linen cloth.



fuma-Bautec GmbH & Co. KG

Carl-Benz-Straße 9 / 59348 Lüdinghausen / GER

Tel. +49 2591 947480 / Fax +49 2591 9474850

kontakt@fuma-bautec.com / www.fuma-bautec.com